

Table of Contents

Drawing Nr	Drawing Title
01	Cover Sheet
02	Typical Site Layout
03	Typical Sections
04	3D View



Digital Diagnost C90 High Performance VS

Document Purpose

This document was prepared by Philips experts to demonstrate an example of correct equipment positioning of a specific Medical Equipment Solution offered by Philips within the space of a theoretical set of rooms. Information provided in this document was prepared for the convenience of facility designers and must be treated only as inspiration for technical design of medical facilities. Philips must be contacted to deliver support in preparing site-specific design that will facilitate the offered Medical Equipment Solution.

Responsibility

Philips does not take responsibility for any changes done to drawings by other parties, any damages resulting from use of information that is presented in this document, any damages caused by not involving Philips representatives in facility design coordination activities related to correct functional planning, room design and designing the layout of equipment that was configured by Philips for the Customer. Philips cannot accept responsibility for any damage caused by introducing facility design changes to rooms that are part of the Philips medical equipment solution that aren't discussed and aligned with Philips. Philips cannot accept responsibility for the partial use of Philips final issue drawings, however caused.





Scaling

All dimensions are indicated either in the Imperial (feet and fractional inches), Metric (millimeters) or both measurement systems. Do not scale from printed pdf files. Philips accepts no responsibility or liability for defective work due to scaling of these drawings.

Design Support

We encourage Customers and their Designers to contact Philips for medical facility design support related to Philips Medical Solutions. Philips will organize delivery of design and documentation support, that is related to the Philips offer and adapted to our Customer's site.

Legend

-  Building Element
-  Warning Light
-  Elements installed on the Ceiling
-  Elements installed on the Floor, Wall or unattached

Code	Description
------	-------------

T001	Warning light
------	---------------

Control Room

EDI9	Eleva Workspot with Eleva Monitor DIDi90
------	--

Examination Room

CSML	CeilingSuspension CSM3Long_VS Track
T099	Emergency Power OFF Switch
VS2W	Digital Diagnost C50 VS2 Wall Mounted Digital
GEN	M-Cabinet CXA with Wallbox
D002	Digital Diagnost C50 TH2 BU3
T013	Earth Reference and Dynamic Main Switch
D017	Cable Outlet
ARWI	WiFi Access Point

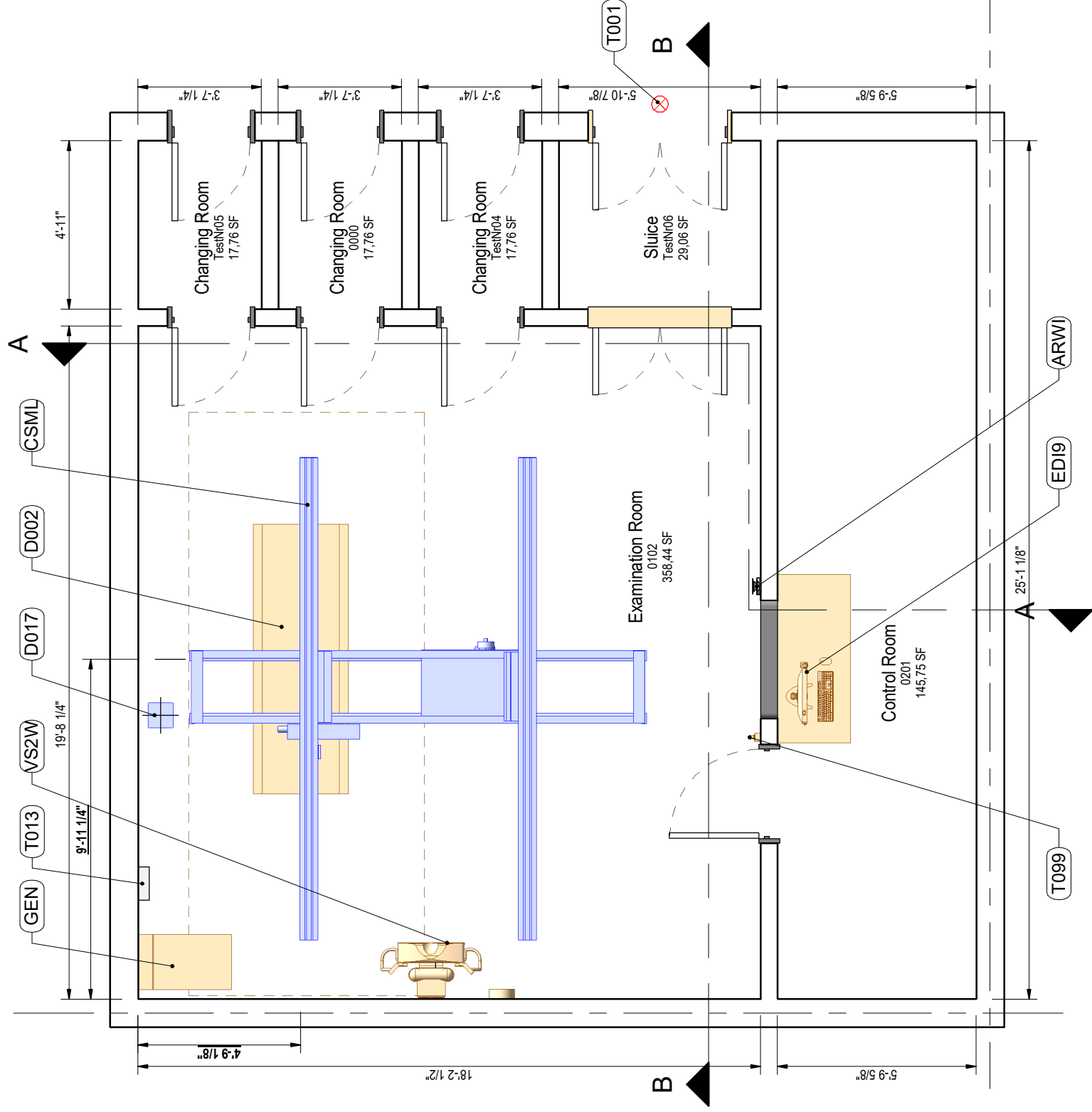

Code	Description
T001	Warning light
Control Room	
ED19	Eleva Workspot with Eleva Monitor DiDi90
Examination Room	
CSML	CeilingSuspension CSM3Long_VS Track
T099	Emergency Power OFF Switch
VS2W	Digital Diagnost C50 VS2 Wall Mounted Digital
GEN	M-Cabinet CXA with Wallbox
D002	Digital Diagnost C50 TH2 BU3
T013	Earth Reference and Dynamic Main Switch
D017	Cable Outlet
ARWI	WiFi Access Point

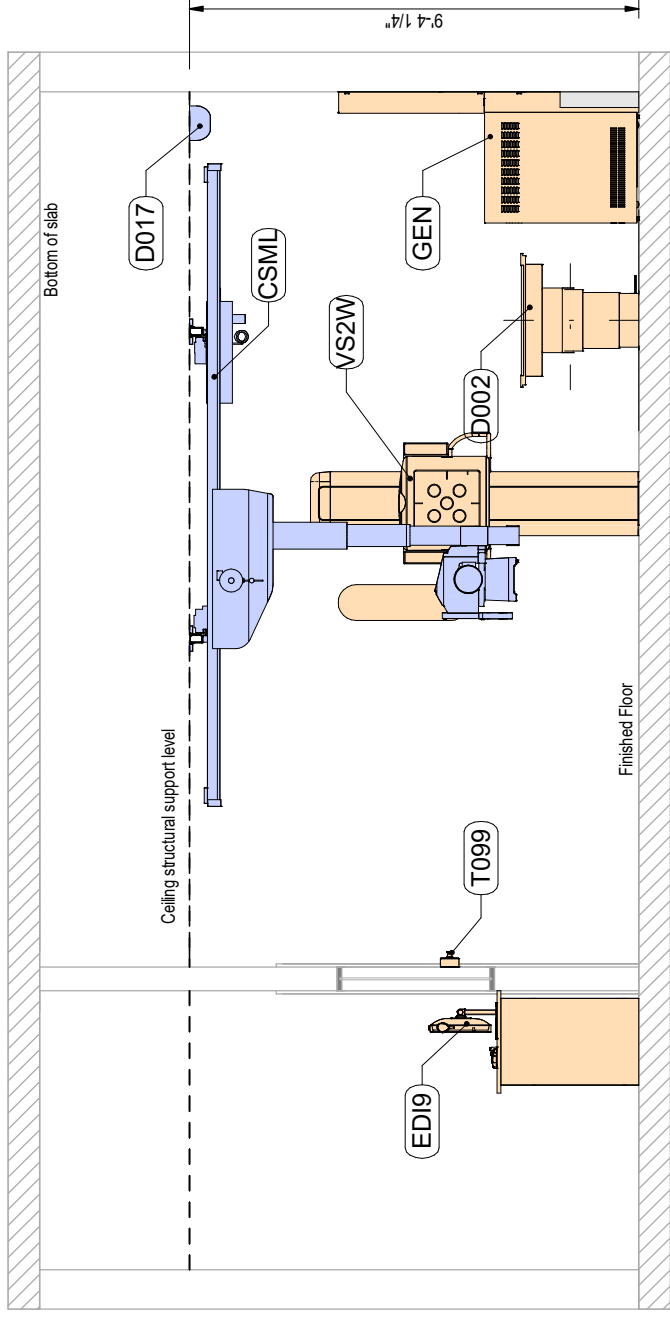

1: Section A

□ 1/4" = 1'-0"

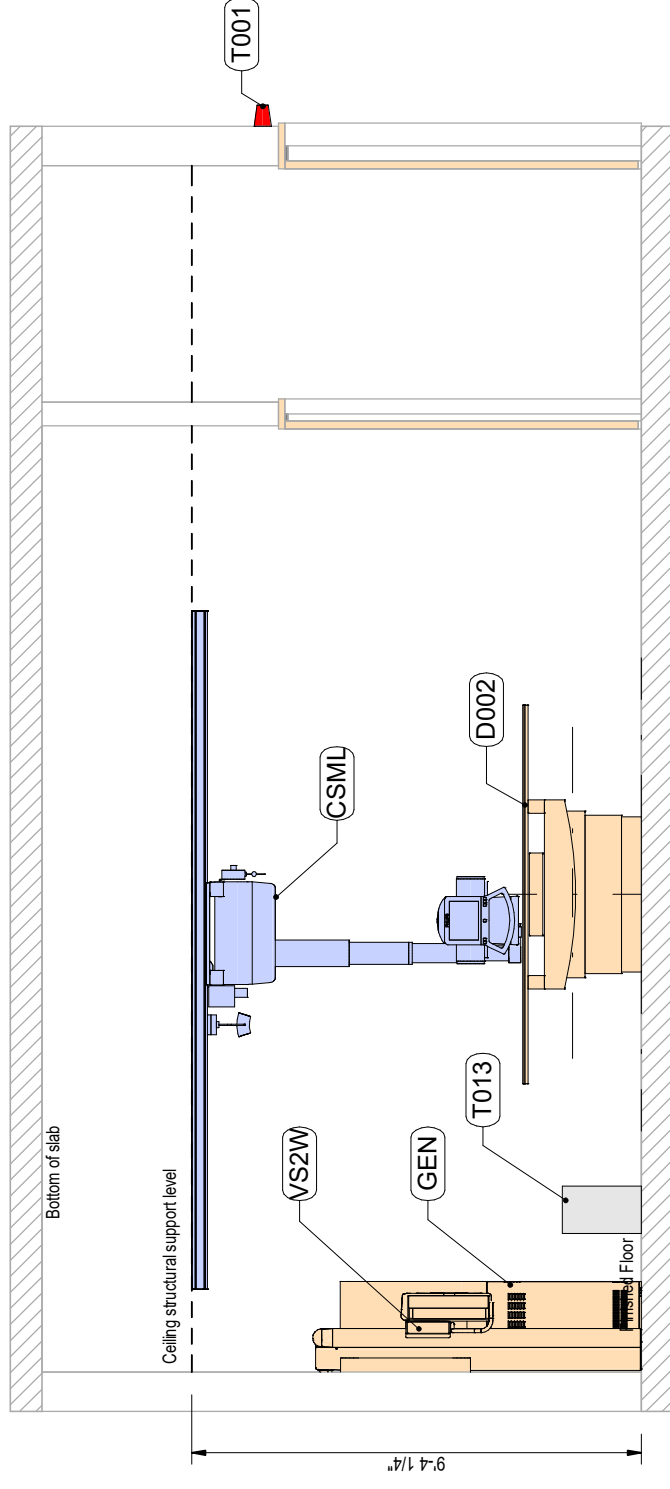

2: Section B

□ 1/4" = 1'-0"

Code	Description
T001	Warning light
Control Room	
ED19	Eleva Workspot with Eleva Monitor DDi90
Examination Room	
CSML	CeilingSuspension CSM3Long_VS Track
T099	Emergency Power OFF Switch
VS2W	Digital Diagnost C50 VS2 Wall Mounted Digital
GEN	M-Cabinet CXA with Wallbox
D002	Digital Diagnost C50 TH2 BU3
T013	Earth Reference and Dynamic Main Switch
D017	Cable Outlet
ARWI	WiFi Access Point

