



Azurion 7 C20

## Table of Contents

Drawing Nr	Drawing Title
01	Cover Sheet
02	Typical Site Layout
03	Typical Sections
04	3D View

### Document Purpose

This document was prepared by Philips experts to demonstrate an example of correct equipment positioning of a specific Medical Equipment Solution offered by Philips within the space of a theoretical set of rooms. Information provided in this document was prepared for the convenience of facility designers and must be treated only as inspiration for technical design of medical facilities. Philips must be contacted to deliver support in preparing site-specific design that will facilitate the offered Medical Equipment Solution.

### Responsibility

Philips does not take responsibility for any changes done to drawings by other parties, any damages resulting from use of information that is presented in this document, any damages caused by not involving Philips representatives in facility design coordination activities related to correct functional planning, room design and designing the layout of equipment that was configured by Philips for the Customer. Philips cannot accept responsibility for any damage caused by introducing facility design changes to rooms that are part of the Philips medical equipment solution that aren't discussed and aligned with Philips. Philips cannot accept responsibility for the partial use of Philips final issue drawings, however caused.





### Scaling

All dimensions are indicated either in the Imperial (feet and fractional inches), Metric (millimeters) or both measurement systems. Do not scale from printed pdf files. Philips accepts no responsibility or liability for defective work due to scaling of these drawings.

### Design Support

We encourage Customers and their Designers to contact Philips for medical facility design support related to Philips Medical Solutions. Philips will organize delivery of design and documentation support, that is related to the Philips offer and adapted to our Customer's site.

**Legend**

-  Building Element
-  Warning Light
-  Elements installed on the Ceiling
-  Elements installed on the Floor, Wall or unattached

Code	Description
------	-------------

T001	Warning Light
------	---------------

**Control Room**

I058	Azurion operating station
T001	Warning Light

**Operating Room**

I062	AD7 Pivot Table
FLP	AD7 Floorplate
I065	Clea FD20 CeilingBased
I072	Monitor Ceiling suspended Flexvision
Mon	2x27inch Monitor on MCS Front
I094	Radiation shield mounted on MCS
I093	Examination light mounted on MCS
I015	Auxiliary Box
I073	MCS Cable Outlet
I095	Larc Cable outlet

**Technical Room**

I003	Imaging Cabinet, B
I004	Frontal Generator Cabinet, E
I002	Peripheral Cabinet, R
I005	Main Electrical Cabinet, M
I006	Documentation Cabinet
T013	Earth Reference and Main Switch

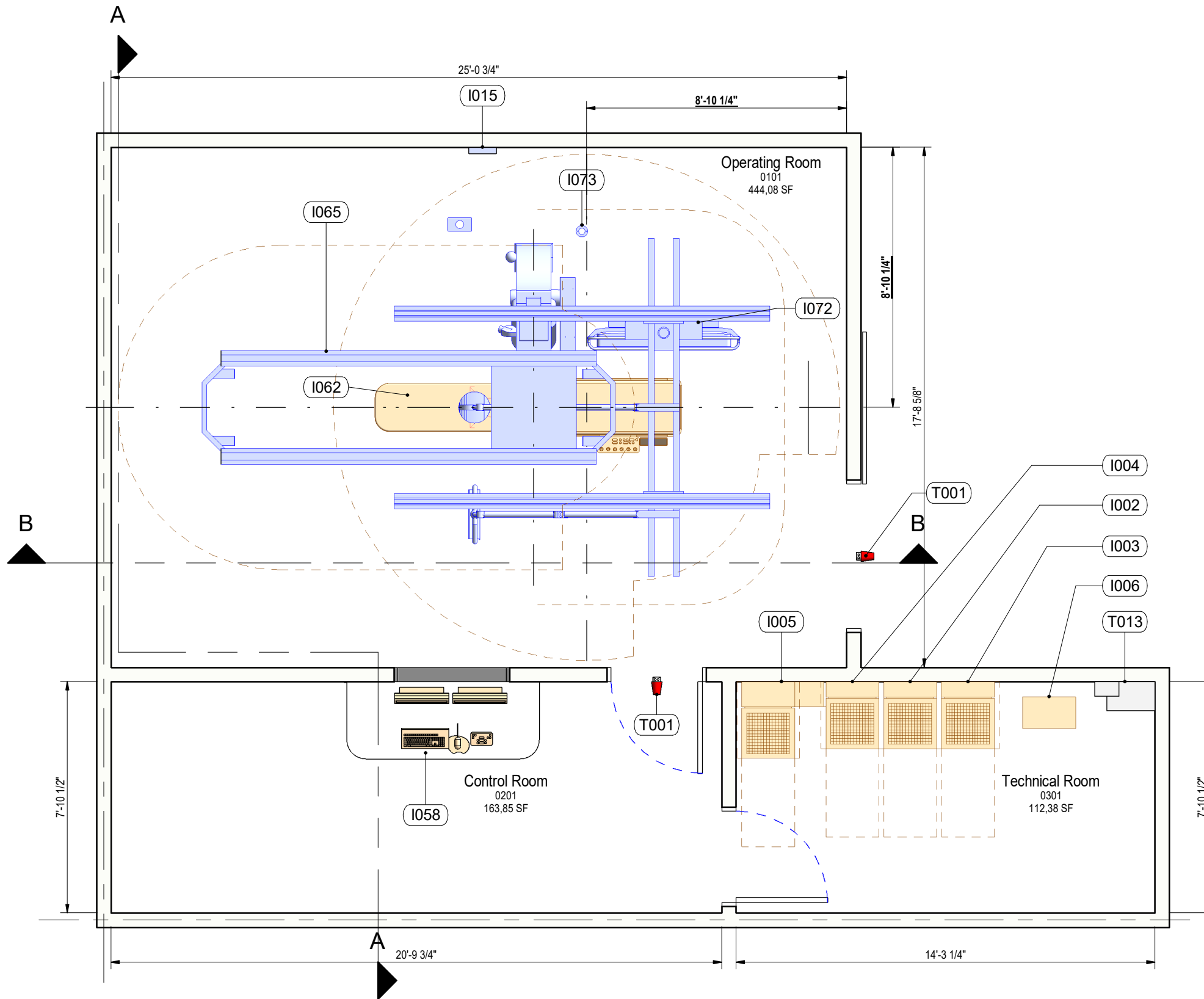

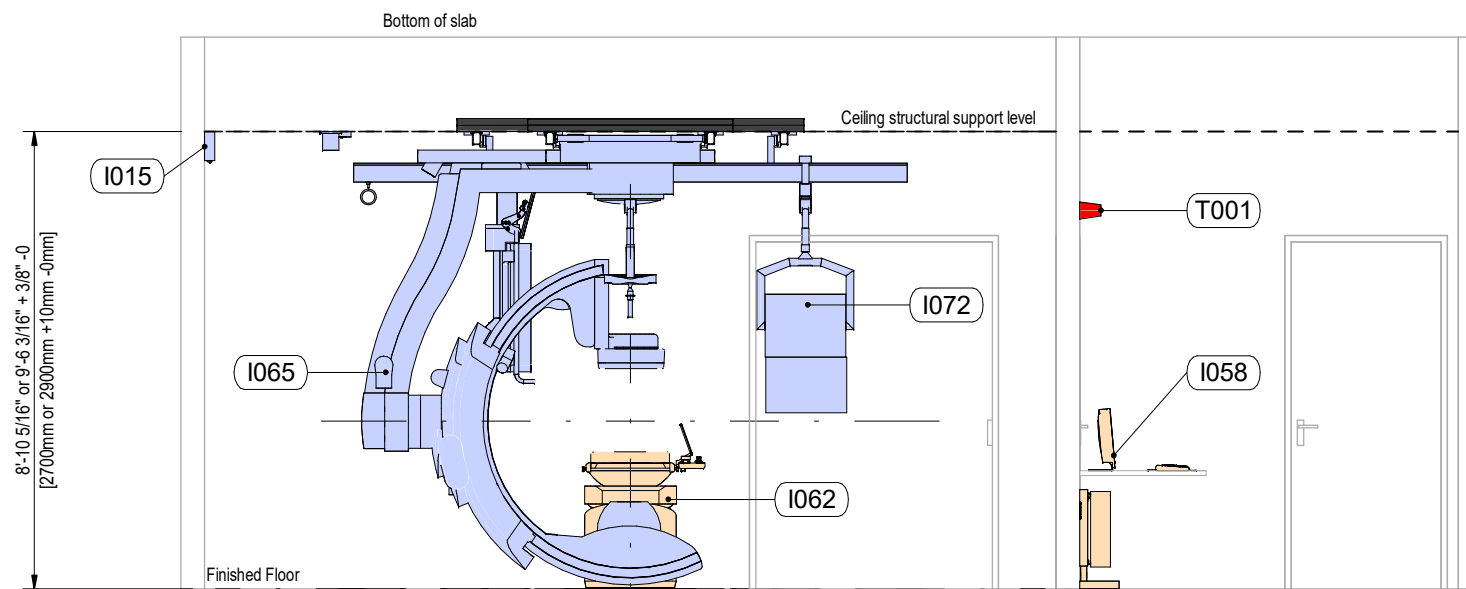

### 1: Section A

□ 1/4" = 1'-0"

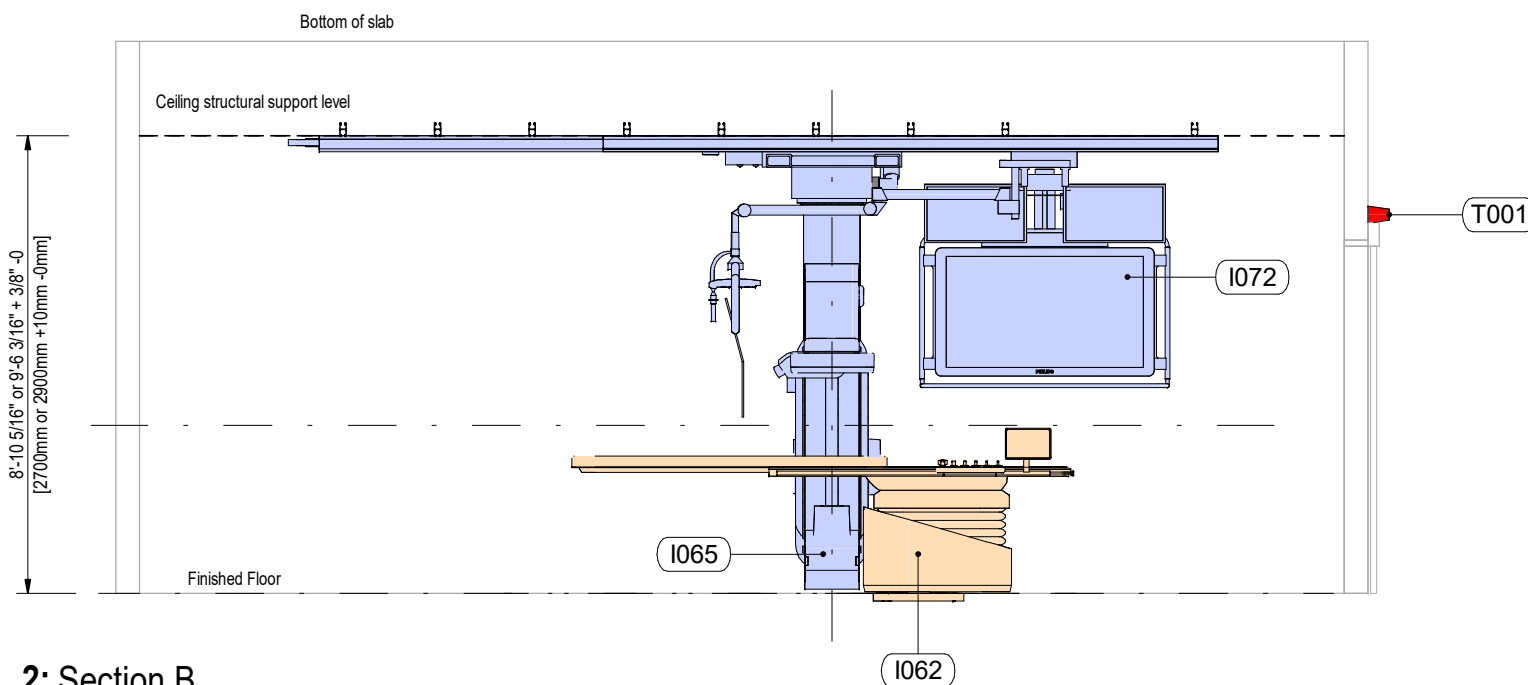

### 2: Section B

□ 1/4" = 1'-0"

Code	Description
------	-------------

T001	Warning Light
------	---------------

#### Control Room

I058	Azurion operating station
T001	Warning Light

#### Operating Room

I062	AD7 Pivot Table
FLP	AD7 Floorplate
I065	Clea FD20 CeilingBased
I072	Monitor Ceiling suspended Flexvision
Mon	2x27inch Monitor on MCS Front
I094	Radiation shield mounted on MCS
I093	Examination light mounted on MCS
I015	Auxiliary Box
I073	MCS Cable Outlet
I095	Larc Cable outlet

#### Technical Room

I003	Imaging Cabinet, B
I004	Frontal Generator Cabinet, E
I002	Peripheral Cabinet, R
I005	Main Electrical Cabinet, M
I006	Documentation Cabinet
T013	Earth Reference and Main Switch

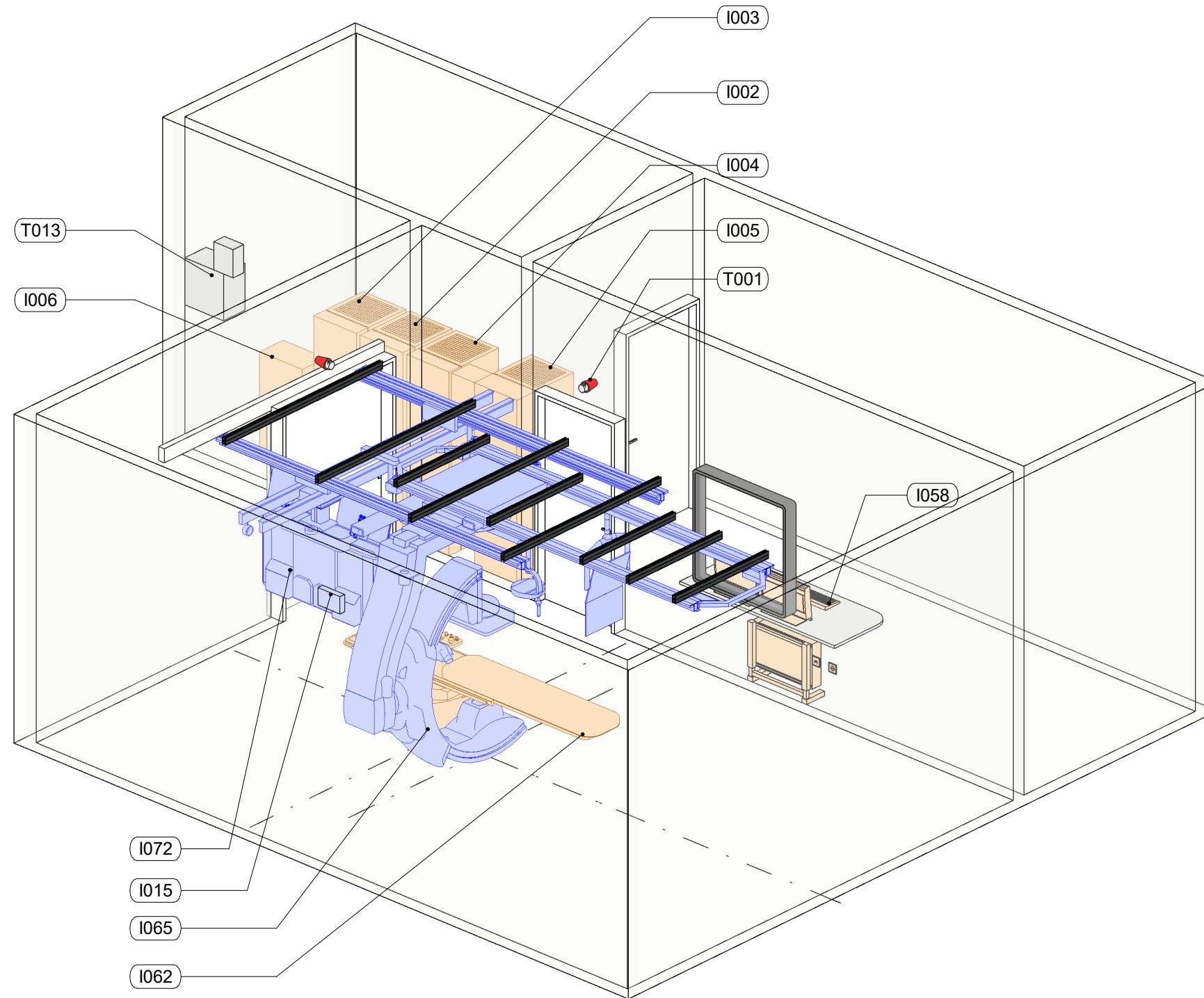

Code	Description
------	-------------

T001	Warning Light
------	---------------

Control Room

I058	Azurion operating station
T001	Warning Light

Operating Room

I062	AD7 Pivot Table
FLP	AD7 Floorplate
I065	Clea FD20 CeilingBased
I072	Monitor Ceiling suspended Flexvision
Mon	2x27inch Monitor on MCS Front
I094	Radiation shield mounted on MCS
I093	Examination light mounted on MCS
I015	Auxiliary Box
I073	MCS Cable Outlet
I095	Larc Cable outlet

Technical Room

I003	Imaging Cabinet, B
I004	Frontal Generator Cabinet, E
I002	Peripheral Cabinet, R
I005	Main Electrical Cabinet, M
I006	Documentation Cabinet
T013	Earth Reference and Main Switch