



Respironics Inc.
1001 Murry Ridge Lane
Murrysville, PA 15668 USA

Respironics Deutschland GmbH & Co. KG
Gewerbestr. 17
82211 Herrsching, Germany



REF 1139736

1139736 R02
JJB 07/02/2019
ENGLISH



PHILIPS
RESPIRONICS

BiPAP A40 Pro

BiPAP A40 EFL



User manual

FOR HOME CARE EQUIPMENT PROVIDER USE ONLY

Access to Prescription Setting Screens

Warning

Information on this page is ONLY for home care equipment providers. Remove this page from the manual before giving the manual to the patient.

Full and Limited Menu Access Modes

The ventilator has two levels of menu access, Full and Limited.

Full Menu Access allows the user to alter all available settings. Limited Menu access allows the user to alter only those prescription settings that affect patient comfort, such as Rise Time or Flex, if they are available as part of the prescription. Turning the Lock settings off in Full Menu Access mode allows users to modify them. The device defaults to Full Menu Access mode. See Chapter 5 for more information.

When the device is in Limited Menu Access mode, use the following key sequence to enter Full Menu Access mode:

1. From the Standby or Monitor screen, press the Down button and the Alarm Indicator/Audio Pause button simultaneously for several seconds. This temporarily places the device in Full Menu Access mode.
2. If you perform this key sequence from the Monitor screen, the Main Menu appears. If you perform it from the Standby screen, the Setup screen appears.
3. An audible indicator sounds indicating you are now in Full Menu Access mode.
4. You can access the Options menu and permanently change the Menu Access setting to Full. Otherwise, the device will return to Limited mode once you exit the menu screens or if one minute passes without pressing any device buttons.

Note: Chapter 5 provides detailed descriptions of the Full and Limited Menu screens.

Note: Philips Respironics recommends that you set the device back to Limited Menu Access mode before returning it to the patient so patients cannot change their prescription settings.

Respironics Inc.
1001 Murry Ridge Lane
Murrysville, PA 15668 USA



Respironics Deutschland GmbH & Co. KG
Gewerbestrasse 17
82211 Herrsching, Germany



0123

REF 1139736

1139736 R02
JJB 07/02/2019
ENGLISH

Table of Contents

Chapter 1. Introduction	1
1.1 Package Contents.....	1
1.2 Intended Use	2
1.3 Contraindications.....	2
1.4 Patient Precautions.....	3
1.5 How to Contact Philips Respironics	3
1.6 Warnings and Cautions.....	4
1.7 System Overview.....	10
1.7.1 Control Buttons	12
1.8 Symbols Glossary	13
1.9 Traveling with the System.....	15
1.9.1 Airline Travel.....	15
Chapter 2. Therapy Modes and Features	17
2.1 Therapy Modes	17
2.2 Therapy Features.....	19
2.2.1 AVAPS.....	19
2.2.2 Bi-Flex Comfort Feature	19
2.2.3 Ramp.....	20
2.2.4 Rise Time	21
2.2.5 Triggering.....	21
2.2.6 Automated Airway Management (AAM).....	22
2.2.7 ExpiraFlow Therapy	22
2.2.8 Setting up ExpiraFlow Therapy.....	23
2.3 Therapy Event Detection.....	24

Chapter 3. Ventilator Alarms.....	25
3.1 Audible and Visual Alarm Indicators	25
3.1.1 Alarm LED Indicators.....	25
3.1.2 Audible Indicators	26
3.1.3 Alarm Messages.....	27
3.2 Silencing an Alarm.....	27
3.3 Resetting an Alarm	27
3.4 Alarm Descriptions	28
3.4.1 Patient Alarms	28
3.4.2 System Alarms.....	29
3.4.3 Informational Messages	31
3.5 What to Do When An Alarm Occurs	34
3.5.1 Follow these Steps when an Alarm Occurs	34
3.5.2 Follow these Steps if Ventilator Inoperative Alarm Occurs	34
3.6 Alarm Summary Table	35
3.6.1 Patient Alarms.....	35
3.6.2 System Alarms.....	36
3.6.3 Informational Messages	38
3.7 System Checkout Procedure.....	41
3.7.1 Verifying the Pressure	41
3.7.2 Verifying the Alarms.....	43
Chapter 4. Device Setup.....	47
4.1 Installing the Air Filter.....	47
4.2 Where to Place the Device	48
4.3 Connecting the Breathing Circuit	48
4.3.1 Connecting a Non-Invasive Circuit	48
4.3.2 Connecting an Invasive Circuit (BiPAP A40 Pro only).....	49

4.4	Supplying Power to the Device	49
4.4.1	Using AC Power.....	49
4.4.2	Using DC Power	50
4.4.3	Device Power Source Indicators.....	52
4.5	Connecting External Patient Monitors.....	54
4.6	Adding Low Flow Oxygen.....	54
Chapter 5	Viewing and Changing Settings.....	57
5.1	Navigating the Menu Screens.....	57
5.2	Using the Keypad Lock Feature.....	57
5.3	Accessing the Standby Screen.....	58
5.4	Accessing the Setup Screen.....	59
5.5	Accessing the Monitor Screen.....	59
5.5.1	Monitor Screen Content.....	60
5.5.2	Visual Leak.....	61
5.5.3	BiPAP A40 EFL with ExpiraFlow enabled	62
5.6	Changing Settings in Provider Menu Access Mode.....	62
5.6.1	Changing Device Settings and Alarms	63
5.6.2	Therapy Settings and Modes (BiPAP A40 Pro).....	64
5.6.3	Therapy Settings and Modes (BiPAP A40 EFL).....	67
5.6.4	Therapy Settings.....	70
5.6.5	Changing Options Menu Settings	77
5.6.6	Viewing the Alarm Log	80
5.6.7	Viewing the Event Log	80
5.6.8	Viewing Device Information	80
5.7	Updating Prescriptions Using the SD Card.....	81
5.8	Changing Settings in Limited Menu Access Mode	82
5.8.1	Changing My Settings Menu Items.....	82
5.8.2	Options Menu Items in Limited Access Mode.....	83
5.9	Display Symbols.....	84

Chapter 6. ExpiraFlow EFL Screening	87
6.1 ExpiraFlow Screening Mode (BiPAP A40 EFL only)	87
6.1.1 Prior to Active Screening	87
6.1.2 Required Accessories	87
6.1.3 Setting up the Patient	88
6.2 Starting the ExpiraFlow Screening Test	89
6.3 Reading Screening Information.....	91
6.3.1 Indicator and Description.....	92
Chapter 7. Cleaning, Disinfection, Service.....	93
7.1 Cleaning and Disinfection Overview	93
7.2 Clearing the Device of Patient Data	94
7.3 Cleaning the Ventilator: Exterior	95
7.4 Disinfecting the Ventilator: Exterior	96
7.5 Air Path Disinfection.....	97
7.6 Cleaning the Reusable Tubing.....	98
7.7 Caring for the Filters	99
7.8 Cleaning and Disinfecting the O ₂ Enrichment Attachment.....	100
7.9 Cleaning and Disinfection of the Detachable Battery.....	101
7.10 Cleaning and Disinfection of the Detachable Battery Module.....	101
7.11 Cleaning and Disinfection of the Whisper Swivel II.....	101
7.13 Wiping Down the Roll Stand.....	102
7.14 Service.....	102

Chapter 8. Accessories	103
8.1 Adding a Integrated System One Humidifier	103
8.2 Adding an External Humidifier	104
8.3 Supplemental Oxygen	104
8.4 Oximeter.....	104
8.5 SD Card.....	105
8.6 Care Orchestrator Essence.....	106
8.7 Respiratory Lithium-Ion Battery	106
8.8 Detachable Battery and Detachable Battery Module	107
8.9 Roll Stand	107
8.10 In-Use Bag.....	107
8.11 Carry Case	107
8.12 Accessory Modules and Modems	108
Chapter 9. Troubleshooting.....	109
Chapter 10. Technical Specifications.....	113
Chapter 11. EMC Information.....	119
Limited Warranty	123

1. Introduction

1.1 Package Contents

Your BiPAP A40 Pro or BiPAP A40 EFL system may include the following components. Some components are optional accessories that may not be packaged with your device.

Note: Not all features and/or modes will display on the ventilator device. The display will vary based on the device model and device settings.

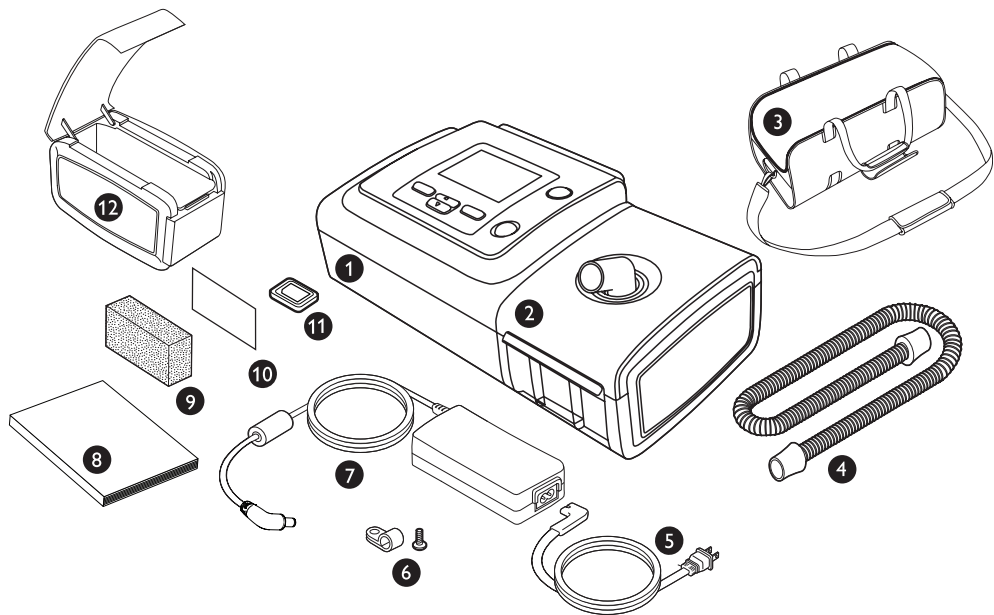

Note: The humidifier and patient tubing supplied with this device may vary in appearance. The humidifier shown above is that of the non-heated tube compatible version.

1	BiPAP device	7	AC power adapter
2	Humidifier	8	Instructions for use
3	Carry case	9	Reusable gray foam filter
4	Flexible tubing (1.8 m x 22 mm)	10	Disposable white ultra-fine filter
5	Power cord	11	SD card
6	Power cord retainer and screw	12	Detachable battery module (optional)

1.2 Intended Use

BiPAP A40 Pro

The BiPAP A40 Pro ventilator is intended to provide invasive and non-invasive ventilatory support to treat adult and pediatric patients weighing over 10 kg (22 lbs) with Obstructive Sleep Apnea (OSA), respiratory insufficiency, or respiratory failure. This device is not intended for life support. It is not intended to be used as a transport ventilator. It is intended to be used both in the home and clinical settings such as hospitals, sleep laboratories, sub-acute care institutions, and portable applications such as wheelchairs and gurneys.

BiPAP A40 EFL

The BiPAP A40 EFL ventilator is intended to provide non-invasive ventilatory support to treat patients weighing over 10 kg (22 lbs) with Obstructive Sleep Apnea (OSA) or Respiratory Insufficiency. It is intended to be used within the home, institutional/hospital, and diagnostic laboratory environments. This device is not intended for life support.

The BiPAP A40 EFL screening and therapy is intended for patients weighing over 30 kg (66 lbs) with Obstructive Sleep Apnea (OSA), or Respiratory Insufficiency with primary cause being Chronic Obstructive Pulmonary Disease (COPD) to screen for the presence, and abolishment of Expiratory Flow Limitation.

1.3 Contraindications

BiPAP A40 Pro and BiPAP A40 EFL

The BiPAP A40 Pro and BiPAP A40 EFL devices are not life support devices.

The device system should not be used on patients with the following conditions:

- Inability to maintain a patent airway or adequately clear secretions
- At risk for aspiration of gastric contents
- Diagnosed with acute sinusitis or otitis media
- Epistaxis, causing pulmonary aspiration of blood
- Hypotension

If the patient has any of the above conditions, consult their health care professional before using the device in a non-invasive mode.

(BiPAP A40 Pro) AVAPS-AE therapy mode is contraindicated for invasive use and patients less than 10 kg (22 lbs.).

1.4 Patient Precautions

- Immediately report any unusual chest discomfort, shortness of breath, or severe headache to your physician or home care equipment provider.
- If skin irritation or breakdown develops from the use of the mask, refer to the mask instructions for appropriate action.
- The following are potential side effects of non-invasive positive pressure therapy:
 - Ear and sinus discomfort
 - Conjunctivitis
 - Skin irritation due to noninvasive interfaces
 - Gastric distention (aerophagia)
 - Drying of nose, mouth or throat
 - Eye irritation
 - Skin rashes

1.5 How to Contact Philips Respironics

Should you experience trouble with this equipment or require assistance setting up, using, or maintaining the device or accessories, contact product support. If you need to contact Philips Respironics directly, call the Philips Respironics Customer Service department at 1-724-387-4000 (USA) or +49 8152 93060 (Germany).

You may also use the following addresses:

Respironics Inc.	Respironics Deutschland GmbH & Co. KG
1001 Murry Ridge Lane	Gewerbestrasse 17
Murrysville, PA 15668 USA	82211 Herrsching, Germany

1.6 Warnings and Cautions

Warnings

A warning indicates the possibility of injury to the user or operator.

Patient Monitoring	<p>Prior to placing a patient on the ventilator, ensure the patient or their current health status are not contraindicated. A clinical assessment should be performed to determine:</p> <ul style="list-style-type: none"> • Device alarm settings • Alternative ventilation equipment • If an alternative monitor should be used (i.e., an alarming Pulse Oximeter or Respiratory Monitor)
Personnel Qualifications	<p>This device is a restricted medical device designed for use by pulmonologists, respiratory clinicians, or other trained and qualified caregivers under the supervision of a physician.</p> <p>The instructions in this manual are not intended to supersede your health care professional's instructions regarding the use of the device. This manual serves as a reference.</p> <p>The prescription and other device settings should only be changed on the order of the supervising physician.</p> <p>The operator should read and understand this entire manual before using the device.</p>
Approved Battery Back-up Power	<p>The device has a two-stage low battery alarm. The medium priority alarm indicates that approximately 20 minutes of operation remain, and the high priority alarm indicates that less than 10 minutes of operation remain. Actual run time may be more or less than this and varies with battery age, environmental conditions, and therapy.</p> <p>Immediately seek an alternate power source when the “Low Battery” alarm appears. Complete power failure and loss of power is imminent.</p> <p>Do not use the same external battery to operate both the ventilator and any other equipment such as power chairs.</p> <p>Do not connect the ventilator to the battery of a battery-powered wheelchair unless the connection is listed in the instructions for use of the ventilator or wheelchair. This can compromise the ventilator performance which consequently can result in degradation of the health of the patient.</p>

Device Operation	Do not cover the ventilator or place in a position that affects proper operation.
	Do not block the intake air vents.
	Do not use the device while positioned in a warm place, such as direct sunlight, or below 5° C (41° F).
	Do not use the ventilator at an altitude above 2286 m (7500 ft) or outside a temperature of 5° C to 40° C (41° F to 104° F). Using the ventilator outside of this temperature range or above this altitude can compromise the ventilator performance which consequently can result in degradation of the health of the patient.
Air Inlet	Make sure the air inlet on the back of the device is not blocked. The device may not work properly if the air flow around the device is blocked or obstructed.
Device Start-Up	Make sure the device is working properly at start-up (when entering standby mode). Always verify that the audible tone sounds and the alarm LEDs light red then yellow momentarily. Contact Philips Respironics or an authorized service center for service if these indications do not occur at start-up. See Chapters 4 and 5 for more information about device start-up.
Bacteria Filter	Philips Respironics recommends that an approved main line outlet bacteria filter be used whenever the device is used on multiple patients.
Therapy Features / Modes	(BiPAP A40 Pro) The AVAPS-AE therapy mode is for non-invasive use. The AVAPS-AE therapy mode is contraindicated for invasive use and patients less than 10 kg (22 lbs.).
Patient Circuits	The device should only be used with patient interfaces (e.g., masks, circuits and exhalation ports) recommended by Philips Respironics. Proper operation of the device, including alarms, with other circuits has not been verified by Philips Respironics and is the responsibility of the health care professional or respiratory therapist.
	An exhalation port is required. Do not block the exhalation port. This can reduce airflow and result in rebreathing of exhaled air.
	At low expiratory pressures, the flow through the exhalation port may be inadequate to clear all exhaled gas from the tubing – some rebreathing may occur.
	When using a patient circuit with a full face mask, the mask must be equipped with a safety (entrainment) valve. Make sure that the safety (entrainment) valve is functioning properly with the device.
	The ExpiraFlow Screening test requires a specific circuit configuration to ensure accurate results. Refer to the instructions in Chapter 6.

Improperly Functioning Ventilator	If you notice unexplained changes in the performance of the device, if it is making unusual sounds, if the device or detachable battery are dropped or mishandled, if water is spilled into the enclosure, or if the enclosure is cracked or broken, discontinue use and contact Philips Respironics or an authorized service center for service. If you are a patient, please contact your home care equipment provider.
Circuit Disconnect	You should not rely on any single alarm to detect a circuit disconnect condition. The Low Minute Ventilation and Apnea alarms should be used in conjunction with the Circuit Disconnect alarm.
	Test the operation of the circuit disconnect function whenever a change is made to the circuit. An increase in circuit resistance can prevent proper operation of some alarms.
Accessories	When using humidification, the inline bacteria filter will require more frequent replacement to prevent increased resistance or blockage.
	When adding any components to the breathing system, the flow resistance and dead space of the added components (such as humidifiers and filters) should be carefully considered in relation to the potential for adverse effects on the patient's ventilatory management and device alarms. For example, adding components to the breathing system may cause the pressure during expiration at the Air Outlet Port to increase.
	To ensure that this equipment delivers safe, effective therapy, use only Philips Respironics accessories. The use of accessories, transducers, and cables other than those specified by Philips Respironics may result in increased emissions or decreased immunity of the device.
Power Cord	Route the power cord to the outlet in a way that will prevent the cord from becoming unplugged, tripped over, or otherwise interfered with by chairs or other furniture when the device is in use. Do not position the device in a way that will make the device difficult to unplug if intended, as unplugging the power cord is the only way to disconnect AC power.
	Only use the power cords recommended by Philips Respironics with the device. Use of power cords and cables not supplied by Philips Respironics may cause overheating or damage to the device.
SD Card Prescription Changes	When making a therapy prescription or alarm setting change with the SD card, the health care professional must review and verify any prescription changes before using the device. The health care professional is responsible to ensure that the prescription settings are correct and compatible with the patient after using this feature. Installing the wrong prescription for a particular patient may result in improper therapy, lack of appropriate safety monitoring, and injury to the patient.

Oxygen	<p>When administering fixed low flow supplemental oxygen, the oxygen concentration delivered to the patient may not be constant. The inspired oxygen concentration will vary, depending on the pressures, patient flow and circuit leak. Substantial leaks may reduce the inspired oxygen concentration to less than the expected value. Use appropriate patient monitoring, as medically indicated, such as setting the SpO₂ alarm to a certain percentage or through the use of an alarming pulse oximeter.</p>
	<p>When using oxygen with this system, the oxygen supply must comply with local regulations for medical oxygen.</p>
	<p>Do not connect the device to an unregulated or high pressure oxygen source.</p>
	<p>Do not operate the device in the presence of flammable gasses. This could cause a fire or explosion.</p>
	<p>Oxygen supports combustion. Oxygen should not be used while smoking or in the presence of an open flame.</p>
	<p>When not using the Oxygen Inlet adapter to incorporate supplemental Oxygen, a Philips Respironics Pressure Valve must be placed at the device outlet. Failure to use the pressure valve could result in a fire hazard.</p>
	<p>Do not use the device near a source of toxic or harmful vapors.</p>
	<p>When using oxygen with the ventilator, turn the device on before turning on the oxygen flow. Turn off the oxygen flow before turning the device off. This will prevent oxygen accumulation in the device.</p>
	<p>Explanation of the Warning: When the device is not in operation and the oxygen flow is left on, oxygen delivered into the tubing may accumulate within the device's enclosure. If oxygen levels increase in the device, the device's evacuation fan will turn on, and if the levels increase high enough will alarm of high internal oxygen levels. Oxygen accumulated in the device enclosure will create a risk of fire.</p>
	<p>The device may result in incorrect flow, tidal volume measurements and improper operation of related alarms if you add low flow oxygen directly into the patient circuit or mask instead of directly adding it into the oxygen inlet on the back of the ventilator.</p>
	<p>Turn off oxygen flow when the device is not in use. When the device is not in operation and the oxygen flow remains on, oxygen delivered into the tubing may accumulate within the device's enclosure.</p>
	<p>Do not use oxygen while the ventilator is contained in the in-use bag or during other mobile situations.</p>

Cleaning	To avoid electrical shock or device damage, always unplug the power cord from the wall outlet and remove any battery cables from the device before cleaning the device.
	Never operate the device if any parts are damaged or if it is not working properly. Replace damaged parts before continuing use.
	Periodically inspect electrical cords and cables for damage or signs of wear. Discontinue use and replace if damaged.
	Repairs and adjustments must be performed by Philips Respironics-authorized service personnel only. Unauthorized service could cause injury, invalidate the warranty, or result in costly device damage.
EMC	The use of accessories, transducers, and cables other than those specified by Philips Respironics may result in non-compliance due to increased emissions or decreased immunity of the device. For optimum performance, the device should only be used with accessories provided by Philips Respironics.
	Medical Electrical Equipment needs special precautions regarding EMC and needs to be installed and put into service according to the EMC information provided in this manual. Use of this equipment adjacent to or stacked with other equipment should be avoided because it could result in improper operation. If such use is necessary, this equipment and the other equipment should be observed to verify that they are operating normally. For more information, contact your home care equipment provider.
	Portable and Mobile Radio Frequency Communications Equipment can affect Medical Electrical Equipment. See the EMC section of this manual for distances to observe between RF Generators and the ventilator to avoid interference.
	Medical Electrical Equipment may be interfered with by other equipment, even if that other equipment complies with CISPR EMISSION requirements.
	Do not use this device near active high frequency surgical equipment and the Radio Frequency shielded room of a Medical Electrical system for magnetic resonance imaging, where the intensity of electromagnetic disturbances is high.
Integrated System One Humidifier	Do not remove the integrated System One humidifier water tank while the humidifier is preheating.
	For safe operation, the integrated System One humidifier must always be positioned below the breathing circuit connection of the mask. The humidifier must be level for proper operation.
External Humidifier	For safe operation, the external humidifier must always be positioned below the breathing circuit connection at the mask and the air outlet on the device. The humidifier must be level for proper operation.

Cautions

A caution indicates the possibility of damage to the device.

Electrostatic Discharge (ESD)	<p>Do not use antistatic or conductive hoses or conductive patient tubing with the device.</p> <p>Pins of connectors marked with the ESD warning symbol shall not be touched and connections shall not be made without special precautions. Precautionary procedures include methods to prevent build-up of electrostatic charge (e.g., air conditioning, humidification, conductive floor coverings, non-synthetic clothing), discharging one's body to the frame of the equipment or system or to earth. It is recommended that all individuals that will handle this device understand these precautionary procedures at a minimum as part of their training.</p>
Condensation	<p>Condensation may damage the device. If the device has been exposed to either very hot or very cold temperatures, allow it to adjust to room temperature (operating temperature) before starting therapy.</p>
Filters	<p>A properly installed, undamaged and clean reusable gray foam filter is required for proper operation.</p> <p>Rinse the reusable gray foam filter at least once every two weeks. Replace the filter when damaged or with a new filter every six months.</p>
Extension Cords	<p>Do not use extension cords with this device.</p>
Device Placement	<p>Do not place the device where the air inlet may be blocked by materials.</p> <p>Do not place the device in or on any container that can collect or hold water.</p> <p>Do not place the device directly onto carpet, fabric, or other flammable materials.</p> <p>Do not plug the device into an outlet controlled by a wall switch.</p>
Integrated System One Humidifier	<p>The heated integrated System One humidifier can only be used when the ventilator is connected to AC power. It cannot be used with a battery.</p>
External Battery	<p>If this device is connected to a deep cycle lead acid battery the Shielded DC Power Cable and DC Battery Adapter Cable are required. An external battery should only be connected to the ventilator using the Philips Respironics External Battery Cable. This cable is fused, pre-wired, and properly terminated to ensure safe connection to a standard deep cycle lead acid battery. Use of any other adapter or cable may cause improper operation of the ventilator.</p>
Cleaning	<p>Do not immerse the device or allow any liquid to enter the enclosure or the inlet filter.</p> <p>Do not steam autoclave the ventilator. Doing so will destroy the ventilator.</p> <p>Do not use harsh detergents, abrasive cleaners, or brushes to clean the ventilator system. Only use the recommended methods provided in the Cleaning and Disinfection section of this manual.</p>

Notes

- The patient or operator accessible areas, the air path, and breathing circuit are not made with DEHP, natural latex rubber or dry natural rubber.
- Any serious incident that has occurred in relation to this device should be reported to Philips and the competent authority of the Member State in which the user and/or patient is established.

1.7 System Overview

The BiPAP A40 Pro ventilator system can provide non-invasive or invasive ventilation.

The BiPAP A40 EFL ventilator system can provide non-invasive ventilation.

The ventilator augments patient breathing by supplying pressurized air through a patient circuit. The device senses the patient's breathing effort by monitoring airflow in the patient circuit and adjusts output to assist inhalation and exhalation. This therapy is known as Bi-level ventilation.

Bi-level ventilation provides a higher pressure, known as Inspiratory Positive Airway Pressure (IPAP), when inhaling, and a lower pressure, known as Expiratory Positive Airway Pressure (EPAP), when exhaling. The device can also provide a single pressure level known as Continuous Positive Airway Pressure (CPAP).

The ventilator can be operated using AC power, a detachable battery, or an external battery. See Chapter 4 for more information.

Accessories are available for use with the ventilator. Contact your home care equipment provider to purchase accessories not included with your system.

The following illustration displays some of the device connectors and features, described in the table that follows.

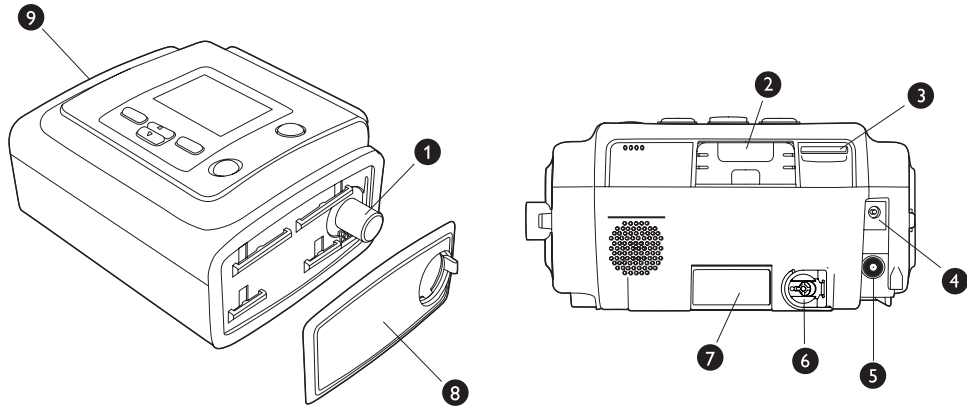

#	Feature	Description
1	Air outlet port	Connect the flexible tubing here. Note: Heated Tubing should only be connected to the Air Outlet Port of the compatible heated humidifier.
2	Accessory slot (with cover)	If applicable, optional accessories such as a cellular and broadband/SpO ₂ modem, and the link module can be installed here. Remove the accessory slot cover to insert an accessory. When the accessory is removed, replace the accessory slot cover. Refer to the instructions supplied with the accessory. Caution: There are several accessories available for your ventilator. When using optional accessories, always follow the instructions enclosed with the accessories.
3	SD card slot	Insert the optional SD card here.
4	DC power inlet	Connect an external battery here using the Philips Respironics DC power cord.
5	AC power inlet	Connect the AC power adapter here.
6	Oxygen inlet port	Add low flow oxygen into the oxygen inlet port by connecting the O ₂ adapter. Push the metallic slide in and then insert the oxygen inlet adapter to connect.
7	Filter area	A reusable gray foam filter must be placed in the filter area to screen out dust and pollen. A disposable white ultra-fine filter can also be used for more complete filtration of very fine particles.
8	Side cover	This side cover can be easily removed for cleaning with the release tab. Note: If using a humidifier with the device, this side cover can be easily removed with the release tab before attaching the humidifier. Refer to the Humidifier Manual for more information.
9	Detachable Battery Module Connection	If you are using the Philips Respironics Detachable Battery Module, attach the Battery Module here and insert the battery into the module. See the instructions included with the Detachable Battery Module for attaching instructions and for more information.

1.7.1 Control Buttons



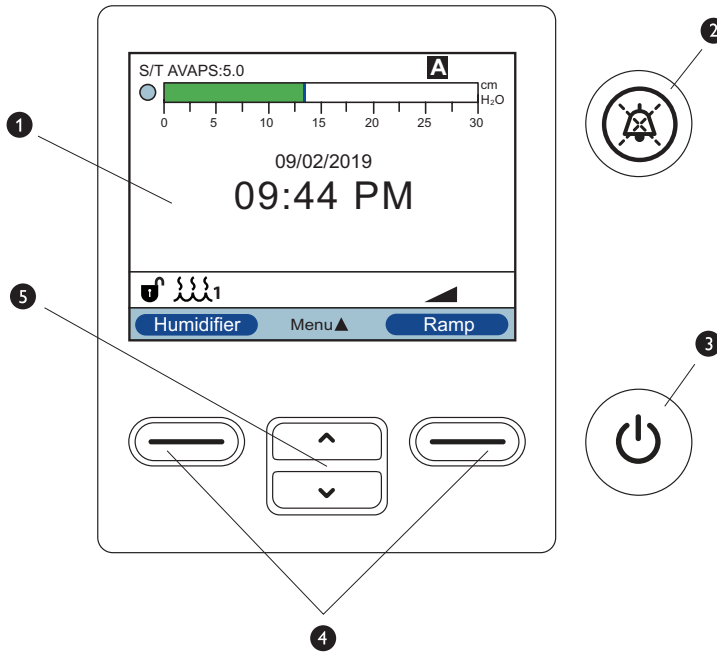











The figure below shows the display screen and primary control buttons on the device.

















#	Feature	Description
1	Display screen	Shows therapy settings, patient data, and other messages.
2	Alarm indicator/audio pause button	This button serves two purposes: it temporarily silences the audible portion of an alarm, and it also acts as an alarm indicator. See Chapter 3 for more information.
3	Start/stop button	Pressing this button when the device is off causes the device to enter Standby mode. Pressing this button while therapy is being delivered displays a pop-up screen that allows for either turning the device off or returning to Standby mode. While running, this button may be pressed for 3 seconds which will stop therapy and will power off the device..
4	Left/right button	These buttons allow selection of display options or to perform certain actions specified on-screen.
5	Up/down button	These buttons allow navigation of the display menu and to edit device settings.

1.8 Symbols Glossary

The following symbols may appear on this device and its packaging.

Symbol	Title and Meaning
	Refer to the instruction manual To signify that the instruction manual must be read.
	Catalogue number Indicates the manufacturer's catalogue number so the medical device can be identified.
	Serial number Identifies the manufacturer's serial number for the medical device.
	Batch Code Identifies the manufacturer's batch or lot code for a medical device or the corresponding packaging.
	Medical Device Indicates that the item is a medical device.
	Unique Device Identifier Indicates the Unique Device Identifier information.
	Packaging unit To indicate the number of pieces in the package.
	Humidity limitation Indicates the range of humidity to which the medical device can be safely exposed.
	Temperature limitation Indicates the storage temperature limits to which the medical device can be safely exposed.
	Manufacturer Indicates the medical device manufacturer.
	Date of Manufacture To indicate the date on which a product was manufactured. Country of Manufacturer To indicate the country of manufacture of the product.
	Class II equipment (Double Insulated) Identifies equipment meeting the safety requirements specified for Class II equipment.
	Type BF applied part To identify a type BF applied part complying with IEC 60601-1.
	DC power (Direct current) Indicates on the rating plate that the equipment is suitable for direct current only; to identify relevant terminals.

Symbol	Title and Meaning
	AC power (Alternating current) Indicates on the rating plate that the equipment is suitable for alternating current only; to identify relevant terminals.
	Therapy on/off (Stand-by) Identifies the button to turn therapy on or off (puts the device in a stand-by condition).
	Unlocking Identifies on a control that a function is not locked.
IP22	Drip proof equipment Protection against ingress of solid foreign objects ≥ 12.5 mm diameter. Protection against ingress of water with harmful effects dripping (15° tilted).
	Audio Pause Indicates that an auditory alarm system is in the audio paused state.
	Non-ionizing electromagnetic radiation Indicates that the equipment includes RF transmitters.
	Electrostatic Sensitive Device (ESD) To indicate packages containing electrostatic sensitive devices.
	Keep away from sunlight Indicates a medical device that needs protection from light sources or heat.
	For indoor use only
	Use only with the power supply 1142982.
	AC Power Supply: connection for the AC/DC power supply
	DC Battery Voltage: connection for an external battery
	Secure Digital (SD) Card Slot
	Oxygen Inlet To identify an input terminal when it is necessary to distinguish between inputs and outputs.
	For Airline Use. Complies with RTCA/DO-160 Section 21, Category M
	Separate collection for electrical and electronic equipment per EC Directive 2012/19/EU.

1.9 Traveling with the System

For your convenience at security stations, there is a notation on the bottom of the device that states the system is medical equipment. It may be helpful to bring this manual along with you to help security personnel understand the device.

If you are traveling to a country with a line voltage different than the one you are currently using, a different power cord or an international plug adaptor may be required to make your power cord compatible with the power outlets of the country to which you are traveling. Please contact your home equipment provider or Philips Respironics for the appropriate country power cord.

1.9.1 Airline Travel

The device is suitable for use on airlines when it is operating from an AC or DC power source.

Note: *The device is not suitable for airline use with any modems or humidifiers installed.*

Note: *If asked about the device suitability for use when traveling by air, refer to the Airline Use symbol on the device label on the bottom of the ventilator for additional information and compliance.*

2. Therapy Modes and Features

2.1 Therapy Modes

Note that not all features and/or modes will display on the ventilator device. The display will vary based on the device model and device settings.

Modes	Description
CPAP	Continuous Positive Airway Pressure maintains a constant level of pressure throughout the breathing cycle.
S	Spontaneous Pressure Support; A Bi-level therapy mode where breaths are patient-triggered and patient-cycled. The device triggers to IPAP (Inspiratory Positive Airway Pressure) in response to spontaneous inspiratory effort and cycles to EPAP (Expiratory Positive Airway Pressure) during exhalation. The device also cycles a patient-triggered breath if no patient exhalation effort is detected for 3 seconds. The level of Pressure Support delivered is determined by the difference between the IPAP and EPAP settings ($PS = IPAP - EPAP$)
S/T	Spontaneous/Timed Pressure Support; A Bi-level therapy mode where each breath is patient-triggered and patient-cycled or machine-triggered and machine-cycled. S/T mode is similar to S mode, in that the device also cycles a patient-triggered breath if no patient exhalation effort is detected for 3 seconds. The device also will enforce a set minimum breath rate by, if necessary, providing machine (time) triggered breaths. For these breaths, the inspiratory time is also a set value.
T (BiPAP A40 Pro only)	Timed Pressure Support; A Bi-level therapy mode where breaths are machine triggered and machine-cycled. T mode provides mandatory pressure assist with bi-level pressures. The patient's breathing rate has no effect on the machine rate or pressure levels. The trigger to IPAP is determined by the breath rate setting, and the cycle time is determined by the inspiratory time setting.
PC	Pressure Control Pressure Support; A Bi-level therapy mode where each breath is patient or machine-triggered and machine-cycled. PC mode is similar to S/T mode, except that all breaths are machine-cycled. This is a pressure-limited, machine or patient-triggered, time-cycled mode. The cycle time is determined by the Inspiratory Time setting.

AVAPS-AE
(BiPAP A40 Pro
only)

AVAPS-AE is a Bi-level therapy mode that automatically adjusts Expiratory Positive Airway Pressure (EPAP), Pressure Support, and the back-up breath rate. AVAPS-AE monitors the resistance in the patient's upper airway and adjusts EPAP automatically to maintain a patent airway.

AVAPS-AE mode also monitors delivered tidal volumes and automatically adjusts pressure support to maintain the designated target tidal volume. AVAPS-AE also has the ability to automatically set and maintain a back-up breath rate (max 20) based on the patient's own spontaneous breathing rate. AVAPS-AE is intended for non-invasive applications only.

The clinician sets a target volume and sets pressure limits. The system uses algorithms to calculate the optimal pressure support required to meet the target. The user can reset the algorithms that are used to calculate all automatic adjustments.

The AVAPS-AE therapy mode is contraindicated for invasive use and patients less than 10 kg (22 lbs.).

Warning: *Limit the pressure setting according to the needs of the prescribed patient population.*

2.2 Therapy Features

If prescribed for you, the device provides the following therapy features.

2.2.1 AVAPS

AVAPS is a feature available in the S, S/T, PC, and T modes. (In AVAPS-AE mode, the AVAPS feature is always enabled.)

AVAPS automatically adjusts pressure to meet a target tidal volume. Inspiratory pressure fluctuates between the minimum and maximum settings to reach the set Tidal volume. EPAP or PEEP remains the same in each breath. AVAPS helps patients maintain a tidal volume target (Tidal Volume setting) by automatically controlling the pressure support (PS) provided to the patient. The AVAPS feature adjusts PS by varying the IPAP level between the IPAP Min and IPAP Max settings (or Pressure Support Min and Pressure Support Max in AVAPS-AE mode). AVAPS will retain the learned PS for the patient so that each time therapy is started the PS will start at the learned PS.

AVAPS Rate

The AVAPS Rate setting allows you to adjust the maximum rate at which the pressure support automatically changes to achieve the target tidal volume. The actual rate may be less than this maximum setting depending on how far the current estimated tidal volume is from the target tidal volume. A higher rate allows the AVAPS therapy feature to change pressure support faster to meet the target tidal volume. It can be set from 0.5 cm H₂O per minute to 5.0 cm H₂O per minute in increments of 0.5 cm H₂O per minute.

2.2.2 Bi-Flex Comfort Feature

If enabled, the device provides a comfort feature called Bi-Flex, available in S mode only.

Bi-Flex levels of 1, 2, or 3 progressively provide pressure relief during exhalation.

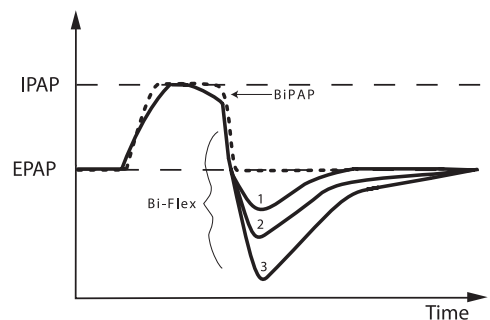

2.2.3 Ramp

The device is equipped with an optional ramp feature. If enabled, the feature is designed to offer lower pressures when activated and then gradually increase to allow the patient to fall asleep. This feature is available in all modes except when ExpiraFlow is enabled.

Refer to the table below for the ramp function with the following:

	AVAPS	AAM	AVAPS + AAM	AVAPS-AE
IPAP (or Pressure Support)	IPAP will reduce to IPAP min and ramp will proportionally increase the IPAP max used for therapy from the IPAP min to the set IPAP max. During the ramp period, the IPAP applied will be adjusted by the AVAPS therapy feature but will be constrained by the current maximum ramp IPAP set point.	Pressure Support will reduce and ramp up to the set Pressure Support over the ramp length period.	Pressure Support (PS) will reduce to PS min and ramp will proportionally increase the PS max used for therapy from the PS min to the set PS max. During the ramp period, the PS applied will be adjusted by the AVAPS therapy feature but will be constrained by the current maximum ramp PS set point.	Pressure Support (PS) will reduce to PS min and ramp will proportionally increase the PS max used for therapy from the PS min to the set PS max. During the ramp period, the PS applied will be adjusted by the AVAPS therapy feature but will be constrained by the current maximum ramp PS set point.
EPAP	EPAP will reduce to ramp start pressure	EPAP will reduce to the set EPAP min	EPAP will reduce to the set EPAP min	EPAP will reduce to the set EPAP min
Auto Back-up Rate	N/A	N/A	N/A	Will reset the auto back-up rate algorithm

2.2.4 Rise Time

Rise Time is available in S, S/T, T, PC, and AVAPS-AE modes. Rise Time is the time required for the ventilator to change from the expiratory pressure setting to the inspiratory pressure setting when a breath is triggered. Rise Time levels from 1 through 6. A setting of 1 is the fastest rise time, while a setting of 6 is the slowest. Rise time cannot be adjusted when Bi-Flex is enabled.

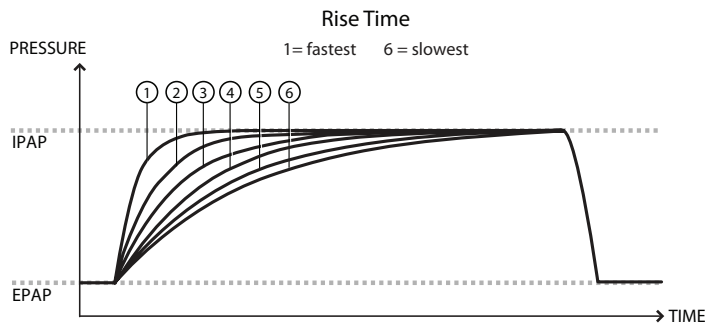

2.2.5 Triggering

Auto-Trak is a combination of multiple triggering algorithms. The parameters of the algorithms are automatically set to synchronize the therapy with a variety of patients.

Sensitive Auto-Trak is a more sensitive version of Auto-Trak.

Flow Trigger initiates a breath when the patient's inspiratory effort creates a flow equal to or greater than the trigger sensitivity setting. A lower number is more sensitive. As inspiratory flow begins to decrease, the device cycles to expiration when the patient flow is less than the percentage of peak flow, based on the flow-cycle sensitivity setting.

2.2.6 Automated Airway Management (AAM)

Automated Airway Management (AAM) is a ventilation feature available in the following modes: S, S/T, PC, and T (depending on which ventilator model is in use).

AAM can be applied to most non-invasive ventilator pressure modes with the goal to provide the minimum amount of EPAP pressure to maintain airway patency. AAM uses high and low proactive EPAP pressure searches based on defined breath intervals to measure changes in the upper airway.

During the breath measurement intervals, Forced Oscillation Technique (FOT) at 5 Hz and 1 cm H₂O amplitude is applied during exhalation to measure changes in the upper airway patency. Based on the changes in upper airway patency, the EPAP will adjust between the minimum and maximum settings by 1 cm H₂O over 5 breaths.

AAM cannot be enabled when ExpiraFlow is enabled; likewise, ExpiraFlow cannot be enabled when AAM is enabled.

Note: Performance of AAM may not be guaranteed when used with an external humidifier.

2.2.7 ExpiraFlow Therapy

ExpiraFlow is a prescribed ventilation feature setting within the BiPAP A40 EFL ventilator that detects and abolishes Expiratory Flow Limitation. ExpiraFlow can be applied to most non-invasive ventilation pressure modes with the goal to abolish Expiratory Flow Limitation breath by breath in COPD patients. It can be enabled in the following modes: S, S/T, and PC.

ExpiraFlow uses forced oscillations at 5 Hz that are continuously applied to each breath's inspiratory and expiratory phase to determine the breath's ΔX_{rs} value. ExpiraFlow will then either automatically raise or lower the EPAP pressure of the next breath within the prescribed minimum and maximum EPAP range based on the the ΔX_{rs} value.

At the same time, ExpiraFlow will also adjust inspiratory pressure by the same EPAP pressure change while maintaining a constant pressure support level. If AVAPS is enabled, the inspiratory pressure may adjust within the minimum and maximum set pressure support range to achieve the set tidal volume.

The ΔX_{rs} value ≥ 2.8 cm H₂O/l/s will increase the next breath's EPAP.

The ΔX_{rs} value ≤ 2.7 cm H₂O/l/s will decrease the next breath's EPAP.

If EPAP pressure changes, pressure support will remain unchanged.

If ΔX_{rs} cannot be calculated, then EPAP will not adjust until the next calculated ΔX_{rs} breath value.

Important notes regarding the ExpiraFlow therapy feature:

- The ExpiraFlow therapy feature is not available when Automated Airway Management (AAM) is enabled.
- Ramp or Ramp Time is not enabled if ExpiraFlow is enabled.
- Selecting if a bacteria filter is applicable during therapy is required if ExpiraFlow is enabled.
- Use only an approved patient mask if ExpiraFlow is enabled.

2.2.8 Setting up ExpiraFlow Therapy

1. Press the Up/Down keys to enter the Menu from the Standby or Monitor screens and navigate to ExpiraFlow.
2. Select the Right (Modify) key and then use the Up/Down keys to turn ON ExpiraFlow therapy.

Menu ► Settings And Alarms		1/23
Mode		S/T
Trigger Type		Auto-Trak
ExpiraFlow		OFF
AVAPS		OFF
▼ AAM		OFF

3. Select the Right (OK) key.
4. Press the Up/Down keys to navigate to the Bacteria Filter Menu item. The Bacteria Filter setting is required if ExpiraFlow is enabled.
5. Select the Right (Modify) key and then use the Up/Down keys to choose YES if a bacteria filter is being used within the patient circuit. Use the Up/Down keys to choose NO if a bacteria filter is not being used.

Menu ► Settings And Alarms		1/25
Mode		S/T
Trigger Type		Auto-Trak
ExpiraFlow		ON
Bacteria Filter		NO
▼ AVAPS		OFF

6. Select the Right (OK) key to confirm the bacteria filter selection. Choosing the Left (Cancel) key will abort the change and return the selection to the previous value.
7. Select the Left (Finish) key when the selection is completed.
8. Set the Minimum and Maximum EPAP Pressure range settings.
9. Set the fixed Pressure Support value.
10. If AVAPS is enabled, Minimum and Maximum Pressure Support and Max Pressure settings are required.

2.3 Therapy Event Detection

The device monitors breathing and detects apneas, hypopneas, and other therapy events (as available).

Event	Definition
Obstructed Airway Apnea /Clear Airway Apnea Detection	<p>An apnea is detected when there is an 80% reduction in airflow from baseline for at least 10 seconds or if there is no airflow detected for 10 seconds. During the apnea, one or more pressure test pulses are delivered by the device. The device evaluates the response of the patient to the test pulse(s) and assesses whether the apnea has occurred while the patient has a clear airway or an obstructed airway. The airway is determined to be clear if the pressure test pulse generates a significant amount of flow; otherwise, the airway is determined to be obstructed.</p> <p>Note: <i>If the device is in a mode that delivers its own back-up breath, (S/T, PC, T, or AVAPS-AE mode), then the device will NOT deliver the test pulse. Instead, it will use the machine back-up breath and evaluate it for which (if any) type of apnea to score.</i></p>
RERA Detection	<p>Respiratory Effort-Related Arousal (RERA) is defined as an arousal from sleep that follows a 10 second or longer sequence of breaths that are characterized by increasing respiratory effort, but which does not meet criteria for an apnea or hypopnea. Snoring, though usually associated with this condition, need not be present. The RERA algorithm monitors for a sequence of breaths that exhibit both a subtle reduction in airflow and progressive flow limitation. If this breath sequence is terminated by a sudden increase in airflow along with the absence of flow limitation, and the event does not meet the conditions for an apnea or hypopnea, a RERA is indicated.</p>
Periodic Breathing	<p>A persistent waning and waxing breathing pattern which repeats itself between 30 and 100 seconds. The nadir of the breathing pattern is characterized by at least a 40% reduction in airflow from an established baseline flow. The pattern must be present for several minutes before it can be identified as periodic breathing.</p>
Hypopnea Detection	<p>A hypopnea is detected when there is an approximately 40% reduction in airflow from baseline for at least 10 seconds.</p>
Snore Detection	<p>Vibration snore is disabled at pressures greater than 16 cm H₂O in CPAP mode. Vibration snore is disabled at IPAP settings greater than 20 cm H₂O or max pressure support (IPAP – EPAP) greater than or equal to 10 cm H₂O in bi-level modes. It is also disabled during any machine triggered breaths when EPAP settings are greater than or equal to 10 cm H₂O.</p>
Large Leak	<p>The level of leak is so large, it is no longer possible to determine respiratory events with statistical accuracy.</p>

3. Ventilator Alarms

There are three types of alarms:

- High Priority – Requires immediate response
- Medium Priority – Requires prompt response
- Low Priority – Requires user awareness. These alarms alert to changes in the device status.

The device also displays informational messages and confirmation alerts that notify of conditions that need attention but are not alarm conditions.

Note: *If multiple alarms occur at the same time, all alarms are processed and displayed, but the alarms are ordered first by priority and then by occurrence, with the newest, highest priority alarms at the top of the list. The alarm precedence is in the following order: high priority, medium priority, low priority, and informational messages.*

Note: *Not all alarms are available in every therapy mode; some alarms are mode-dependent.*

3.1 Audible and Visual Alarm Indicators

When an alarm condition occurs:

- The alarm LED indicator on the Alarm Indicator/Audio Pause button lights
- The audible alarm sounds
- A message appears on the screen describing the type of alarm

Each of these is described in detail below.

3.1.1 Alarm LED Indicators

The Alarm Indicator/Audio Pause button on the front of the ventilator lights up as follows whenever an alarm is detected:

- Red Flashing Indicator – When the device detects a high priority alarm, the Alarm Indicator/Audio Pause button flashes red.
- Yellow Flashing Indicator – When the device detects a medium priority alarm, the Alarm Indicator/Audio Pause button flashes yellow.
- Yellow Solid Indicator – When the device detects a low priority alarm, a solid yellow light appears on the Alarm Indicator/Audio Pause button.

The Alarm Indicator/Audio Pause button does not light up when informational messages or confirmation alerts display.

3.1.2 Audible Indicators

An audible indicator sounds whenever a power failure or a high, medium, or low priority alarm is detected. Additionally, an audible indicator sounds for informational messages and to confirm that certain actions have occurred (for example, when an SD card is inserted or removed from the device).

- Ventilator Inoperative Audible Indicator – When this alarm occurs, a continuous audible alarm sounds. The alarm descriptions later in this chapter display this indicator as: ██████████
- Power Failure Audible Indicator – When a power failure occurs, a series of beeps sounds in a 1 beep pattern, repeating one second on, then one second off. The alarm descriptions later in this chapter display this indicator as: ◇ ◇
- High Priority Audible Indicator – When a high priority alarm is detected, a series of beeps sound in the following pattern, which is repeated twice: 3 beeps, a pause, and then 2 more beeps. This indicator continues until the cause of the alarm is corrected or the audible alarm is paused. The alarm descriptions later in this chapter display this indicator as: ◇◇◇ ◇◇
- Medium Priority Audible Indicator – When a medium priority alarm is detected, a series of beeps sound in a 3-beep pattern. This pattern repeats until the cause of the alarm is corrected or the audible alarm is paused. The alarm descriptions later in this chapter display this indicator as: ◇◇◇
- Low Priority Audible Indicator – When a low priority alarm is detected, a series of beeps sound in a 2-beep pattern. This pattern repeats until the cause of the alarm is corrected or the audible alarm is paused. The alarm descriptions later in this chapter display this indicator as: ◇◇
- Informational Messages and Confirmation Audible Indicators – When an informational message appears on screen, a brief, 1- beep audible indicator sounds. Additionally, when the device detects that a certain action has been completed (for example, when the Start/Stop button is pressed to start therapy, or when an SD card is inserted or removed from the device) a brief, 1- beep audible indicator sounds. The alarm descriptions later in this chapter display this indicator as: ◇

Note: For the alarm indicators noted throughout this manual, each “diamond” represents an audible beep.

3.1.3 Alarm Messages

When the device detects an alarm, the Alarms and Messages Screen is displayed showing a description of the alarm condition. When an alarm message appears, it will be highlighted in red if it is a high priority alarm or in yellow if it is a medium or low priority alarm. (The highlight color matches the alarm LED color on the Alarm Indicator/Audio Pause button.) If an alarm is manually reset by the user, the Alarms and Messages screen is removed and the Monitoring Screen is re-displayed. If the alarm self-cancels, the Alarms and Messages screen remains displayed, but the highlight for the active alarm is removed, the LED is unlit, and the audible alarm stops.

3.2 Silencing an Alarm

When an alarm occurs, you can temporarily silence the audible indicator by pressing the Alarm Indicator/Audio Pause button. The alarm is silenced for 60 seconds and then sounds again if the cause of the alarm has not been corrected. Each time you press the Alarm Indicator/Audio Pause button, another 60 second period is initiated.

When Audio Pause is active, the Alarm Indicator/Audio Pause symbol () appears if you are on the Monitor screen.

There is also a Pre-silence alarm feature. You can press the Alarm Indicator/Audio Pause button at any time to begin a 60 second silence period. If an alarm occurs during that time the audible indicator will not sound until the silence period ends.

3.3 Resetting an Alarm

The Reset button clears the currently active alarm(s) from the display and stops the LED and audible alarm indicator. This button should be selected after the situation causing the alarm(s) has been corrected. Pressing this button cancels all active alarms and restarts alarm detection.

The device self-cancels certain alarms if the cause of the alarm is corrected, shutting off the alarm LED, the audible alarm, and the alarm background color. You can manually reset an alarm by pressing the Left button (Reset). An active alarm silence function is cancelled when any alarm is manually reset.

3.4 Alarm Descriptions

This section describes all of the therapy device alarms and informational messages.

3.4.1 Patient Alarms (User-Settable)

Circuit Disconnect

This is a high priority alarm. It occurs when the breathing circuit is disconnected or has a large leak. The device continues to operate. The alarm will automatically stop when the circuit is reconnected or the leak is fixed. Select Off to disable the alarm. Or, choose 15 or 60 seconds and the alarm will sound after the circuit has been disconnected for that amount of time.

Note: *The circuit configuration for detecting a circuit disconnect alarm condition may vary depending on the intended ventilatory support.*

Apnea

This is a high priority alarm. It occurs when the patient has not triggered a breath within the time specified in the apnea alarm setting. The device continues to operate. The alarm will automatically stop when two consecutive patient breaths are detected that meet the apnea alarm time setting. Select Off to disable the alarm. Or, increase or decrease the setting from 10 to 30 seconds in 10 second increments. The alarm will sound if the time between spontaneous breaths exceeds the selected amount of time.

High Respiratory Rate

This is a high priority alarm. It occurs when the respiratory rate is greater than the High Respiratory Rate alarm setting. The device continues to operate. The alarm will automatically stop when the measured respiratory rate is less than the High Respiratory Rate alarm setting. Select Off to disable this alarm. Or, increase or decrease the setting from 4 BPM to 60 BPM in increments of 1. The alarm will sound when the measured respiratory rate reaches or exceeds this setting.

Low Tidal Volume

This is a high priority alarm. It occurs when AVAPS is enabled (or AVAPS-AE mode in BiPAP A40 Pro) and the device is unable to reach the target tidal volume setting. If the pressure is within 0.9 cm H₂O of the IPAP Max and the measured volume is less than or equal to 90% of target volume for 60 seconds, the alarm is generated. The device continues to operate. The alarm will automatically stop when the target tidal volume is reached. Select On to enable the alarm or Off to disable it. When enabled, the alarm will sound if the target tidal volume can't be reached.

Low Minute Ventilation

This alarm is a high priority alarm. It occurs when the patient's minute ventilation is less than the Low Minute Ventilation alarm setting. The device continues to operate. The alarm will automatically stop when the calculated minute ventilation is greater than the Low Minute Ventilation alarm setting. Select Off to disable this alarm. Or, increase or decrease the setting from 1 l/min to 99 l/min in increments of 1. The alarm will sound when the calculated minute ventilation is less than or equal to this setting.

Low SpO₂

This is a high priority alarm. When an oximetry module is attached, it occurs when the measured SpO₂ is less than the Low SpO₂ setting while the device is delivering therapy. The device continues to operate. The alarm will automatically stop when the measured SpO₂ is equal to or greater than the Low SpO₂ alarm setting for approximately three seconds or more. Select Off to disable the alarm. Or, increase or decrease the setting from 50% to 95% in increments of 1. The default setting is at 85%.

3.4.2 System Alarms

Ventilator Inoperative

This occurs when the device detects an internal error or a condition that may affect therapy. The device will shut down if the cause of the failure indicates that the device cannot deliver therapy.

For facility based clinicians, immediately remove the patient from the device and connect them to an alternate source of ventilation.

Patients, contact your home care equipment provider for service.

Pressure Regulation

This is a high priority alarm. It occurs when the device cannot regulate pressure within an acceptable accuracy. The device continues to operate.

Low Circuit Leak

This is a high priority alarm. It occurs when the device detects that the exhalation port is partially or fully occluded, or the circuit does not contain an exhalation port.

High Temperature

This is a high priority alarm. It occurs when the device detects a motor temperature in excess of 125° C (257° F) for ten seconds. If the temperature drops below 115° C (239° F), the alarm will automatically stop. The device continues to operate. Likewise, it occurs if the detachable battery temperature exceeds 55° C (131° F) for 5 minutes while discharging. If the battery temperature drops below 55° C (131° F), the alarm will automatically stop.

High Internal Oxygen

This is a high priority alarm. This alarm is for low pressure oxygen input (Low Flow O₂) and occurs when the oxygen concentration inside of the device reaches or exceeds 25%. The alarm will stop when the internal oxygen concentration falls below 25% inside the unit.

Loss of Power

This is a technical alarm that is treated as a high priority alarm. It occurs when a complete power failure has occurred and power was lost while the device was providing therapy, or in Standby.

Low Battery

This is a high priority alarm that occurs in two stages. The Low priority Battery alarm occurs when the battery is low or nearly depleted. The medium priority alarm indicates that when approximately 20 minutes of operation remain, a medium priority alarm is generated. The device continues to operate. If no action is taken and the battery continues to deplete, the alarm escalates to a high priority alarm when approximately 10 minutes of operation remain. Actual run time may be more or less than this and varies with battery age, environmental conditions, and therapy.

Loss of SpO₂ Signal

This is a high priority alarm. It occurs if the Low SpO₂ alarm is not set to OFF and the oximeter is reporting invalid data, or the oximeter is disconnected for more than 10 seconds while the device is delivering therapy. The device continues to operate. The alarm will automatically stop when the SpO₂ probe is properly attached to the device and to the patient and the oximeter reports data for approximately three seconds or more. Select Off to disable the alarm. The default setting is On.

O₂ Sensor Failure

This is a medium priority alarm. It occurs when there is a fault detected with the internal O₂ sensor. After the alarm condition is acknowledged, it will not return until the next power cycle. The device continues to operate.

AC Power Disconnected

This is a medium priority alarm. It occurs when the AC power source was lost, and the device has switched to DC (battery) power. The device continues to operate. The alarm stops when the device begins operating from AC power again.

Keypad Stuck

This is a low priority alarm. It occurs when a key becomes lodged inside the case of the device.

Replace Detachable Battery

The Replace Detachable Battery alarm occurs when the detachable battery is nearing the end of its useful life or a failure in the detachable battery that prevents it from charging or discharging has been detected. The alarm may be an informational message or a medium priority alarm. The device may continue to operate depending on the power state condition causing the alarm.

Insert SD Card

This is a low priority alarm. It occurs when a pulse oximeter is connected to the therapy device and there is no SD card inserted in the device while in Standby or Therapy modes. The device continues to operate but no oximeter data is recorded on an SD card.

3.4.3 Informational Messages

Card Error

This informational message occurs when an unusable SD card is inserted into the therapy device. The device continues to operate but data cannot be logged onto the SD card.

Heated Tube Failure

This informational message occurs when failure has occurred with the heated tube accessory connected to the attached heated humidifier accessory. The device continues to operate however heated tube functionality is disabled.

Humidifier Failure

This informational message occurs when failure has occurred with the heated humidifier accessory attached to the device. The device continues to operate however heated humidifier functionality is disabled.

O₂ Fan Failure

This informational message occurs when the O₂ fan has failed while in Standby or Therapy modes. After the alarm condition is acknowledged, the informational message will stop displaying when the O₂ fan returns to proper operation.

Excessive Rtotal (Respiratory System Resistance)

When ExpiraFlow is enabled in the BiPAP A40 EFL ventilator, this informational message occurs when there is excessive Respiratory System Resistance and the ventilator can no longer assure that the prescribed therapy is being delivered.

Excessive Leak

When ExpiraFlow is enabled in the BiPAP A40 EFL ventilator, this informational message occurs when there is an excessive leak and the ventilator can no longer assure that the prescribed therapy is being delivered.

Start On Battery

This informational message indicates that the device has started on battery power and no AC power is available. The device user should verify that this is what is intended.

Check AC Power Supply

This informational message occurs when the AC power input to the therapy device is incorrect. The device continues to operate but therapy may not start.

External Battery Disconnected

This informational message occurs when an external battery is disconnected from the therapy device while operating. The device continues to operate on AC power.

External Battery Depleted

This informational message occurs when the external battery is fully depleted. The device continues to operate using the detachable battery if it is available.

Battery Discharging Stopped Due to Temperature

This informational message occurs when the detachable battery becomes overheated while providing power for the device. The device continues to operate. The detachable battery is not used and the power source is switched to the next available power source.

Battery Not Charging Due to Temperature

This informational message occurs when the detachable battery becomes too hot while charging or the device was in too cold or hot an environment before charging started. The device continues to operate. Detachable battery charging stops until the battery cools or warms sufficiently.

Battery Not Charging

This informational message occurs when the device has detected a condition that prevents the battery from accepting a charge. The device continues to operate. Battery charging stops.

Detachable Battery Disconnected

This informational message occurs when the detachable battery power source is lost and the device has switched to an alternate power source. If the detachable battery power returns, the device will beep, but no message will appear on the display.

3.5 What to Do When An Alarm Occurs

3.5.1 Follow these Steps when an Alarm Occurs

1. Whenever an alarm occurs, first always observe the patient to be sure that adequate ventilation and oxygenation (if appropriate) are available.
2. Review the alarm indicators to determine if the audible Alarm Indicator/Audio Pause button is red or yellow, and whether the LED is solid or flashing.
3. Look at the display to check the alarm message that appears on-screen and whether it is highlighted in red or yellow.
4. If you want to silence the alarm temporarily, press the Alarm Indicator/Audio Pause button to silence the audible alarm. A visual indicator displays (). Or, press the Left (Reset) button to reset alarm. In case of Loss of Power, use the Alarm Indicator/Audio Pause button to both silence and stop the alarm, and provide back-up ventilation and oxygen therapy.
5. Look up the alarm in the alarm descriptions in this chapter to determine the source of the alarm and the appropriate action.

3.5.2 Follow these Steps if Ventilator Inoperative Alarm Occurs

1. Press the Start/Stop button.
2. If the ventilator display is operational, the “Power Off” confirmation screen will appear. Select the Right button to shut off the device and silence the alarm.
3. Immediately remove the patient from the ventilator and if required, connect them to an alternate source of ventilation.
4. Contact your home care equipment provider for service.

3.6 Alarm Summary Table

The following tables summarize the high, medium, and low priority alarms and informational messages.

3.6.1 Patient Alarms

Alarm	Priority	Audible	Visual Indicators	Device Action	User Action
Circuit Disconnect	High	◇◇◇ ◇◇	Red flashing button; “Circuit Disconnect” message	Operates	Reconnect the patient circuit or fix the leak. If alarm continues to occur, contact your home care equipment provider. If the device will not exit circuit disconnect, switch to an alternate source of ventilation.
Apnea	High	◇◇◇ ◇◇	Red flashing button; “Apnea” message	Operates	Continue using device. Report the alarm to your home care equipment provider.
Low Tidal Volume	High	◇◇◇ ◇◇	Red flashing button; “Low Vte” message	Operates	Continue using device. If alarm continues, contact your home care equipment provider.
Low Minute Ventilation	High	◇◇◇ ◇◇	Red flashing button; “Low Minute Ventilation” message	Operates	Continue using device. If alarm continues, contact your home care equipment provider.
High Respiratory Rate	High	◇◇◇ ◇◇	Red flashing button; “High Respiratory Rate” message	Operates	Continue using device. If alarm continues, contact your home care equipment provider.
Low SpO ₂	High	◇◇◇ ◇◇	Red flashing button; “Low SpO ₂ ” message	Operates	Continue using device. If alarm continues, contact your home care equipment provider.



3.6.2 System Alarms

Alarm	Priority	Audible	Visual Indicators	Device Action	User Action
Ventilator Inoperative	Technical	████████	Red flashing button; "Ventilator Inoperative" message	Shuts down if device can't provide therapy safely. Or, continues to operate at a limited level.	Press the Start/Stop button. If the ventilator display is operational, the Power Off confirmation screen will appear. Select the Right button to shut off the device and silence the alarm. Immediately remove the patient from the ventilator and connect them to an alternate source of ventilation. Contact your home care equipment provider for service.
Pressure Regulation	High	◇◇◇ ◇◇	Red flashing button; "Pressure Regulation" message	Operates	Check for blockages or excessive leaks. If alarm continues, contact your home care equipment provider.
Low Circuit Leak	High	◇◇◇ ◇◇	Red flashing button; "Low Circuit Leak" message	Operates	Check for blockages in exhalation devices. Be sure the exhalation device and mask exhalation port are clean and functioning properly. If the alarm continues, contact your home care equipment provider.
High Temperature	High	◇◇◇ ◇◇	Red flashing button; "High Temperature" message	Operates	Move device to cooler location. Be sure the device is not close to a heat source. Be sure the back of the device is not blocked. If condition persists, contact your home care equipment provider.
High Internal Oxygen	High	◇◇◇ ◇◇	Red flashing button; "High Internal Oxygen" message	Continues to operate Internal oxygen level reaches 25% or above.	Disconnect supplemental oxygen from device. Check external oxygen connection. If alarm continues, contact your home care equipment provider.
Loss of SpO ₂ Signal	High	◇◇◇ ◇◇	Red flashing button; "Loss of SpO ₂ " Signal message	Operates	Continue using device. If alarm continues, contact your home care equipment provider.

Alarm	Priority	Audible	Visual Indicators	Device Action	User Action
O ₂ Sensor Failure	Medium	◇◇◇	Yellow flashing button; O ₂ Sensor Failure message	Operates	If supplemental oxygen is in use, disconnect the supplemental oxygen from the device. If alarm continues, contact your home care equipment provider.
Loss of Power	Technical	◇ ◇	Red flashing button; Blank screen	Shuts down	If using AC power, try plugging device into alternate AC power source. If loss of power continues, switch to DC power by connecting an external battery to the device. If there is still no power, connect patient to alternate source of ventilation and contact your home care equipment provider.
Low Battery (When Battery is Attached)	Escalates from Medium to High	◇◇◇ (Medium - when approx. 20 minutes remains) ◇◇◇ ◇◇ (High - when approx. 10 minutes remains)	Medium Priority - Yellow flashing button; Low External Battery message appears in yellow; on status panel, box around battery is yellow. High Priority - Red flashing button; Low External Battery message appears in red; on status panel, box around battery is red.	Operates	Switch to an alternate battery, or AC power while you recharge the low battery. If low battery is recharged and alarm continues, replace battery.
AC Power Disconnected (When Battery is Attached)	Medium	◇◇◇	Yellow flashing button; AC Power Disconnected message, and a box appears around battery in use.	Switches to alternate power source	Check AC power adapter and reconnect it if it has become disconnected. Be sure the device is not connected to an overloaded AC circuit.
Stuck Key	Low	◇◇	Solid yellow button; Keypad Stuck message.	Operates	Check the keys to determine if they are lodged in the case. If alarm continues, if required, place patient on alternate source of ventilation and contact your home care equipment provider.

Alarm	Priority	Audible	Visual Indicators	Device Action	User Action
Replace Detachable Battery	Info or Medium, depending on cause of alarm	◇ for Info ◇◇ for Medium	Replace Detachable Battery message appears. If battery is nearing end of useful life, message appears. If battery fails, message appears and button flashes yellow.	Operates	Switch to an alternate battery or AC power source while replacing the current detachable battery.
Insert SD Card (When Oximeter is Attached)	Low	◇◇	Solid yellow button; Insert SD Card message	Operates	Insert an SD card into the device or remove the oximeter.

3.6.3 Informational Messages

Message	Priority	Audible	Visual Indicators	Device Action	User Action
Card Error	Info	◇	Card Error message	Operates	Remove SD Card and use another card, if available. Be sure the card meets specifications. If condition persists, contact your home care equipment provider.
Heated Tube Failure	Info	None	Flashing icon: 	Device operates; Humidifier shuts down	Tubing may be overheating or malfunctioning. Turn off airflow and reconnect the heated tubing to the humidifier according to the humidifier instructions. If the alert continues to occur, contact your home care equipment provider.
Humidifier Failure	Info	None	Flashing icon: 	Device operates; Humidifier shuts down	Turn off airflow and reconnect the humidifier to the device according to the humidifier instructions. If the alert continues to occur, contact your home care equipment provider.

Message	Priority	Audible	Visual Indicators	Device Action	User Action
O ₂ Fan Failure	Info	None	O ₂ Fan Failure message	Operates	If supplemental oxygen is in use, disconnect the oxygen from the device and immediately remove the patient from the ventilator. Provide the patient with supplemental oxygen and connect if required, to an alternate source of ventilation. If the alarm continues, contact your home care equipment provider.
Excessive Rtotal (Respiratory System Resistance) (When ExpiraFlow is enabled in BiPAP A40 EFL)	Info	◇	Excessive Rtotal message	Operates	There may be excessive total system resistance. Ensure the patient is properly titrated to reduce or eliminate upper airway flow limitation. If the alert continues to occur, contact your home care equipment provider.
Excessive Leak (When ExpiraFlow is enabled in BiPAP A40 EFL)	Info	◇	Excessive Leak message	Operates	The ventilator can no longer assure that the prescribed therapy is being delivered due to an excessive leak. Check the patient circuit for loose connections or circuit damage. Adjust or replace the mask to reduce leaks or to improve mask fit. If the alert continues to occur, contact your home care equipment provider.
Start On Battery	Info	◇	Start On Battery message	Operates	Check battery status. Connect to AC power source as soon as possible.
Check AC Power Supply	Info	◇	Check AC Power Supply message	Operates	Connect device to a battery and remove AC power. Replace the AC power supply. If condition persists, contact your home care equipment provider.

Message	Priority	Audible	Visual Indicators	Device Action	User Action
External Battery Disconnected	Info	◇	Ext Batt Disconnected message	Operates	Check the connection to the battery if not an intentional disconnection.
External Battery Depleted	Info	◇	Ext Batt Depleted message	Operates	Replace depleted external battery with another or switch to AC power, if available. Recharge depleted external battery.
Battery Discharging Stopped Due to Temperature	Info	◇	Batt Discharge Stopped - Temp message	Operates	Move device to cooler location. Be sure the device is not close to a heat source. Be sure cooling vents are not blocked. If condition persists, contact your home care equipment provider.
Battery Not Charging Due to Temperature	Info	◇	Batt Not Charging - Temp message	Operates	Be sure the device is not close to a heat source. Be sure cooling vents are not blocked. Move device to a cooler location. If device is too cold, allow it to warm up. If condition persists, contact your home care equipment provider.
Battery Not Charging	Info	◇	Detach Battery Not Charging message	Operates	Replace the battery or find an alternate power source. If condition continues, contact your home care equipment provider.
Detachable Battery Disconnected	Info	◇	Det Batt Disconnected message, and a box appears around battery in use.	Switches to alternate power source	Check connection of the detachable battery to the device. Check the charge available on detachable battery and recharge battery if necessary.

3.7 System Checkout Procedure

3.7.1 Verifying the Pressure

WARNING: If the device fails to perform within the stated specifications, have the system serviced by a qualified Philips Respironics approved service facility.

If part of your patient setup procedure is to verify actual pressure with a manometer, use the following instructions to be sure that the device is functioning properly.

You will need the following equipment to verify the pressure (see illustration):

1. Philips Respironics Pressure Calibration Kit Includes:

- Philips Respironics Whisper Swivel II ①
- Philips Respironics O2 Enrichment Final Assembly ②
- Closed end cap ③

2. Philips Respironics flexible tubing ④

3. Pressure tubing ⑤

4. Philips Respironics Digital Manometer ⑥ or equivalent

Minimum Specifications:

- 0 - 25 cm H₂O (or better)
- ± 0.3 cm H₂O accuracy
- ± 0.1 cm H₂O resolution

5. Foam filter (not shown)

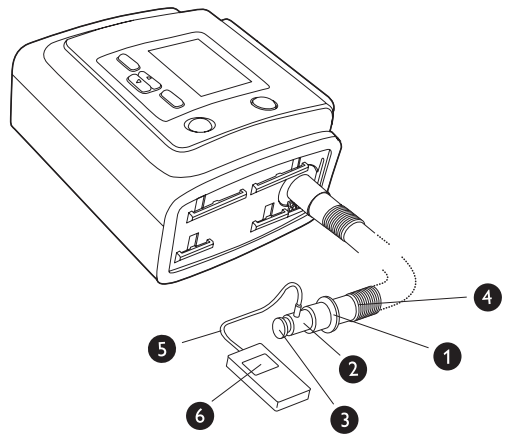

To verify the pressure, complete the following steps:

1. Install the foam filter into the back of the device.
2. With the device unplugged, connect the system as illustrated in the diagram.
3. Turn the manometer on. If it does not display a reading of zero, adjust the manometer to calibrate it. If the manometer has variable settings for devices, set it to cm H₂O.
4. Supply power to the device.
5. Place the device in Full Menu Access mode.
6. Set the therapy parameters according to the patient specific data.
7. Set the device to the specific pressure value for the patient.
8. Press the left button to Finish and then Exit to the Standby screen.
9. Press the Therapy button.
10. Verify that the pressure setting matches the pressure displayed on the manometer. If the pressure setting does not match the measured value for the device, contact Philips Respironics or an authorized service center to have the device serviced.
11. Enter Full Menu Access mode and set up remaining parameters.
12. Press the left button to Finish and then Exit to the Monitoring screen.
13. Press the Start/Stop button and then press right button to Exit to the Standby screen. The unit is ready for patient use.

3.7.2 Verifying the Alarms

Use the test setup from the Verifying the Pressure instructions in Section 3.7.1 for the following tests.

IMPORTANT: *The following steps assume that the steps in Section 3.7.1 have been run first.*

IMPORTANT: *When testing is complete and before patient use, an authorized individual should adjust the device to the appropriate patient settings.*

Circuit Disconnect Alarm Test

Note: *The Circuit Disconnect Alarm relies on a fixed relationship between the patient pressure settings and the open circuit flow of the patient circuit. Verify that the Circuit Disconnect Alarm operates properly with the patient pressures and circuit.*

1. While in the Standby screen press the Therapy button.
2. Place the device in Full Menu Access mode.
3. Set the Apnea Alarm setting to Off.
4. Set the Circuit Disconnect Alarm setting to 15 seconds.
5. Press the left button to Finish and then Exit to the Monitoring screen. Remove the closed end cap. Verify that the Circuit Disconnect Alarm occurs in approximately 15 seconds.
6. Press the Alarm Silence/Indicator button to silence the alarm, and wait for one minute until the alarm sounds again.
7. Press the Reset button to clear the alarm.
8. Replace the closed end cap.
9. Set the Circuit Disconnect Alarm to Off.
10. Press the Start/Stop button and then press right button to Exit to the Standby screen.

Apnea Alarm Test

1. While in the Standby screen press the Therapy button.
2. Place the device in Full Menu Access mode.
3. Set the Apnea Alarm setting to 10 seconds.
4. Press the left button to Finish and then Exit to the Monitoring screen and start therapy. Verify that the Apnea Alarm occurs in approximately 10 seconds.
5. Press the Alarm Silence/Indicator button to silence the alarm, and wait for one minute until the alarm sounds again.
6. Press the Reset button to clear the alarm.
7. Set the Apnea Alarm setting to Off.
8. Press the Start/Stop button and then press right button to Exit to the Standby screen.

Low Minute Ventilation Alarm Test

1. While in the Standby screen press the Therapy button.
2. Place the device in Full Menu Access mode.
3. Connect the device to an approved circuit, whisper swivel II leak device, and test lung.
4. Observe the displayed Min Vent parameter.
5. Set the Low Minute Ventilation Alarm to a value greater than the displayed Min Vent parameter on the bottom of the Monitoring screen. Verify that the Low Minute Ventilation Alarm occurs.
6. Press the Alarm Silence/Indicator button to silence the alarm, and wait for one minute until the alarm sounds again.
7. Press the Reset button to clear the alarm.
8. Set the Low Minute Ventilation Alarm setting to Off.
9. Press the Start/Stop button and then press right button to Exit to the Standby screen.

High Respiratory Rate Alarm Test

Before testing the alarm, attach the test lung, verify ventilator settings, and power on the ventilator.

1. Modify the High Breath Rate Alarm ventilator setting to be greater than the breath rate generated by the test lung.
2. Wait and verify the following alarm signals:
 - The High Priority Audible Indicator sounds
 - A red light flashes on the Alarm Indicator/Audio Pause button
 - The Apnea alarm condition appears on the screen, highlighted in red
3. Set the High Breath Rate Alarm ventilator setting to Off.
4. Verify Reset. Wait at least 2 breaths and verify the following auto-reset conditions:
 - The High Priority Audible Indicator has stopped sounding
 - The red light on the Alarm Indicator/Audio Pause button has stopped flashing

Loss of Input Power Alarm Test (with Detachable Battery)

1. Secure the Detachable Battery Module to the device. Be sure an adequately charged battery is used.
2. Power on the device and select any therapy mode. Disconnect the power cord from the device.
3. The device will switch over to battery operation. The display shows “AC Power Disconnected” and a tone sounds.
4. Select Reset. A black box will appear around the battery indicator to show the ventilator is running on battery power.
5. Power the device off. Testing is complete.

Loss of Power Alarm Test

1. While the device is providing therapy, remove the power connector and verify that Loss of Power alarm sounds.
2. Reconnect power and verify that the device resumes providing therapy.

4. Device Setup

4.1 Installing the Air Filter

The device uses a gray foam filter that is washable and reusable, and a white ultra-fine filter that is disposable. The reusable filter screens out normal household dust and pollen, while the ultra-fine filter provides more complete filtration of very fine particles. The gray reusable filter must be in place at all times when the device is operating. The ultra-fine filter is recommended for people who are sensitive to tobacco smoke or other small particles. One reusable gray foam filter is supplied with your device. A disposable ultra-fine filter is also included.

If your filter is not already installed when you receive the device, you must at least install the reusable gray foam filter before using the device. To install the filter(s):

1. If you are using the white disposable ultra-fine filter, insert it into the filter area first, with the smooth side facing toward the device.
2. Insert the required gray foam filter into the filter area after the ultra-fine filter.

Note: *If you are not using the white disposable filter, simply insert the gray foam filter into the filter area.*

Note: *See Chapter 7 for information on how to clean and replace the air filters.*

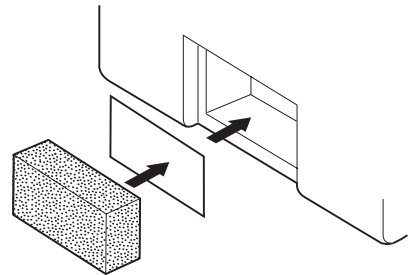

4.2 Where to Place the Device

Place the device upright on a firm flat surface somewhere within easy reach of where you (or the patient) will use it, at a level lower than your sleeping position.

Be sure the filter area on the back of the device is not blocked by bedding, curtains, or other items. Air must flow freely around the device for the system to work properly. Make sure the device is away from any heating or cooling equipment (e.g., forced air vents, radiators, or air conditioners).

4.3 Connecting the Breathing Circuit

You will need the following accessories in order to assemble the recommended circuit:

- Philips Respironics interface (nasal mask or full face mask) with integrated exhalation port, or Philips Respironics interface with a separate exhalation device (such as the Whisper Swivel II)
- Philips Respironics flexible tubing (22 mm or 15 mm) or heated tubing

Note: See Chapter 7 for information on how to clean Philips Respironics flexible tubing prior to use. See separate instructions for use that accompany other breathing circuit components for any necessary cleaning prior to use.

4.3.1 Connecting a Non-Invasive Circuit

Complete the following steps to connect a non-invasive breathing circuit:

1. Connect the flexible tubing to the air outlet on the side of the device.
 - a. If required, connect a bacteria filter to the device air outlet, and then connect the flexible tubing to the outlet of the bacteria filter.
 - b. When using the bacteria filter, the device performance may be affected. However, the device will remain functional and deliver therapy.

Note: When using the optional heated tubing, attach the heated tubing to the humidifier's modified air outlet port, with the bacteria filter installed in-line, but at the patient end of the tubing.

2. Connect the tubing to the mask. Refer to the instructions that came with your mask.
3. Attach the headgear to the mask if necessary. Refer to the instructions that came with your headgear.

4.3.2 Connecting an Invasive Circuit (BiPAP A40 Pro only)

1. Connect the flexible tubing to the air outlet on the side of the device.
 - a. If required, connect a bacteria filter to the device air outlet, and then connect the flexible tubing to the outlet of the bacteria filter.
 - b. When using the bacteria filter, the device performance may be affected. However, the device will remain functional and deliver therapy.
2. If humidification is needed, connect an invasive humidifier or Heat Moisture Exchange filter (HME). An invasive humidifier meeting EN ISO 8185 is recommended.
3. Connect the flexible tubing to the humidifier or HME, and then place an exhalation device (such as the Whisper Swivel II) in line on the patient end.
4. Connect a trach adapter to the exhalation device if needed, and then attach the patient's trachestomy tube.
5. Refer to Chapter 5 to set the System One Resistance setting to Invasive.

4.4 Supplying Power to the Device

The device can operate on AC or DC power. The device accesses power from potential sources in the following order:

- AC Power
- Detachable Battery Pack
- Respiratory Lithium-Ion Battery (or deep cycle marine battery)

4.4.1 Using AC Power

An AC power cord and power supply is included with the device.

1. Plug the socket end of the power cord into the power supply.
2. Plug the pronged end of the power cord into an electrical outlet that is not controlled by a wall switch.
3. Plug the power supply cord's connector into the power inlet on the back of the device.
4. Be sure that all connections are secure.

- There is an accessory clip that can be used to secure the power cord to prevent accidental disconnection. Route the cord through the clip and secure the clip to the enclosure of the device using the supplied screw, as shown.

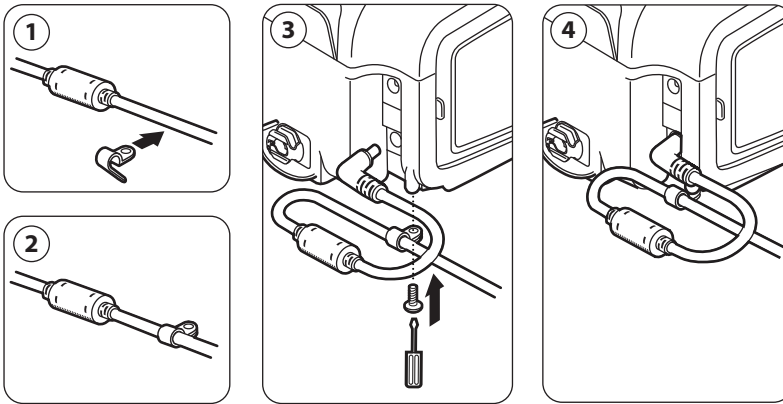

4.4.2 Using DC Power

The ventilator may operate using the following DC power options.

Note: The availability of DC power options is not meant to suggest that this product can be used as a transport device.

Note: When the AC power adapter is not in use, Philips Respironics recommends disconnecting the power adapter from the ventilator.

Detachable Battery

Philips Respironics offers a detachable Lithium-Ion battery pack. You can connect the detachable battery to the device and recharge the battery using the Philips Respironics Detachable Battery Module. Refer to the instructions included with your Detachable Battery Pack and Detachable Battery Module for more information.

Note: The Detachable Battery pack will automatically recharge whenever it is connected to the therapy device and the device is running on AC power.

Respiratory Lithium-Ion Battery

Philips Respironics offers a Respiratory Lithium-Ion Battery. You can connect the lithium-ion battery to power the device. Refer to the instructions included with your Respiratory Lithium-Ion Battery for more information.

Note: *The ventilator will not recharge the Respiratory Lithium-Ion Battery. It must be charged separately.*

Lead Acid Battery

The ventilator may operate from a 12 VDC lead acid marine battery using the Philips Respironics External Battery Cable. This cable is pre-wired and properly terminated to ensure safe connection of an external battery to the device. Battery operating time depends on the characteristics of the battery and usage of the device.

Due to a variety of factors, including battery chemistry, age, and use profile, the capacity of the lead acid battery as shown on the device display is only an estimate of the actual remaining capacity.

Refer to the instructions supplied with the External Battery Cable for detailed information on how to operate the device using a lead acid battery.

Note: *The ventilator will not recharge the lead acid battery. It must be charged separately.*

Limitations

The following are limitations of using DC power:

- Humidifier will not operate while using DC or battery power
- Lead acid battery and Respiratory Lithium-Ion Battery cannot be recharged while the device is using AC power
- If the device is using AC power during therapy and humidification is being delivered, the detachable battery may charge

4.4.3 Device Power Source Indicators

There are many power source indicators on the device and the display screen. These indicators are described in detail below.



AC Power Indicators

When AC power is applied to the device and the airflow is off, the green AC LED indicator on the Start/Stop button lights. When AC power is applied and the airflow is on, the white AC LED indicator on the Start/Stop button lights.

DC Power Indicators





When DC power is applied to the device, battery symbols will appear on-screen to indicate the battery status. The detachable and external battery symbols will only appear on-screen if a detachable or external battery is attached to the device. The shading in the battery icon indicates the power remaining in the battery.

Refer to the Display Symbols table in Chapter 5 for information on each external battery symbol. Refer to the instructions included with your detachable battery for information on each detachable battery symbol.

Battery	Symbol
External Battery	
Detachable Battery	

There are several DC power indicators that will display on-screen to indicate which battery is in use (if applicable), if the batteries are low, charging, or discharged, etc.

The following table explains all of the DC power indicators.

DC Power Indicator	Description
Battery in Use Indicator 	A black box will appear around the battery that is in use. For instance, if the external battery is currently in use, the () symbol appears on-screen.
Green Fully Charged Battery Indicator	When a battery is charged to greater than 90% of its capacity, all of the bars in the battery symbol will appear in green.
Partially Charged Battery Indicator	When a battery symbol is partially charged, some of the bars in the battery symbol will appear in green, while others will be clear. For instance, if the external battery is 50% charged, the following symbol displays on-screen: 
Yellow Low Battery Indicator (Medium Priority)	When the device detects that an in-use battery's charge is low (has approximately 20 minutes of charge left), the inside of the box surrounding the battery symbol turns yellow. (In addition, a medium priority alarm message will display indicating "Low Battery." See Chapter 3 for more information. The yellow indicator is for the last available battery source.
Red Low Battery Indicator	When the device detects that an in-use battery's charge is nearly depleted (has approximately 10 minutes of charge left), the inside of the box surrounding the battery symbol turns red. In addition, a high priority alarm message displays indicating "Low Battery." See Chapter 3 for more information. The red indicator is for the last available battery source.
Yellow Battery Recharging Symbol 	Whenever AC power is applied to the device, the detachable battery will recharge as needed. If the detachable battery is being recharged, the () symbol displays.

4.5 Connecting External Patient Monitors

Connect external patient monitors, such as a pulse oximeter, if using. For help, refer to the accessory's instructions and Chapter 8 in this manual.

4.6 Adding Low Flow Oxygen

Low Flow Oxygen

Warning: Do not operate the device in the presence of flammable gasses. This could cause a fire or explosion.

Note: Low Flow Oxygen may be added to the ventilator in any ventilation mode or while using any feature.

Note: The source of oxygen must be dry gas and can be from "wall gas", cylinders, stationary and portable oxygen concentrators.

When adding oxygen to the circuit, the supply must comply with local regulations for medical oxygen.

The oxygen flow into the oxygen valve must not exceed 15 l/min at a maximum pressure of 10 psi.

1. Connect the oxygen tubing to the O₂ adapter.
2. Connect the O₂ adapter to the low flow oxygen inlet. Push in the metallic slide before inserting the oxygen connector on the back panel. Press the adapter down onto the valve. To release the oxygen connector, push in the metallic slide to eject and then pull.

Note: If the oxygen inlet port is not used to incorporate supplemental oxygen, the pressure valve must be used.

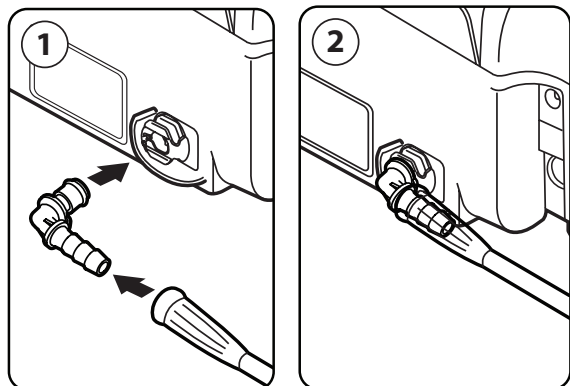

Warnings:

- Do not use oxygen while smoking or in the presence of an open flame.
- Do not connect the device to an unregulated oxygen source.
- Do not connect the device to a high-pressure oxygen source.
- Be sure that the ventilator is powered on when using oxygen.
- Turn off oxygen flow when the device is not in use. When the device is not in operation and the oxygen flow remains on, oxygen delivered into the tubing may accumulate within the device's enclosure.
- Do not use oxygen while the ventilator is contained in the in-use bag or during other mobile situations.
- When administering fixed low flow supplemental oxygen, the oxygen concentration delivered to the patient may not be constant. The inspired oxygen concentration will vary, depending on the pressures, patient flow and circuit leak. Substantial leaks may reduce the inspired oxygen concentration to less than the expected value. Use appropriate patient monitoring, such as setting the SpO₂ alarm to a certain percentage or through the use of an alarming pulse oximeter, as medically indicated.
- The device may result in incorrect flow and tidal volume measurements and improper operation of related alarms if you add low flow oxygen directly into the patient circuit or mask instead of directly adding it into the oxygen inlet on the back of the ventilator.

Note: *Use of Low Flow Oxygen must comply with IEC 60601-1 3.1 requirements when used in conjunction with Oxygen Rich Environments.*

5. Viewing and Changing Settings

5.1 Navigating the Menu Screens

To navigate through all of the menu screens and settings:

- Use the Up/Down button to scroll through the menu.
- Use the Left and Right buttons to perform the actions specified on the on-screen buttons.

5.2 Using the Keypad Lock Feature

Note: When Keypad Lock is enabled, the Alarm Indicator/Audio Pause and Start buttons continue to function normally.

1. Access the Keypad Lock feature from the Options menu. It is intended to prevent accidental changes to device settings. This feature locks the navigation keys (Up, Down, Stop, Left, and Right).
2. If the keypad is locked, you must unlock it before you can enter the Menu. When you press one of the navigation keys, a Keypad Unlock message displays. To unlock the keypad, refer to the Full and Limited Menu Access Modes section at the beginning of the instructions manual.
3. Once the display is unlocked, you can enter the Menu as you normally would by pressing the Up button.
 - There is a keypad lock inactivity time-out period. After you have unlocked the keypad as indicated, the keypad will re-lock after five minutes of inactivity.

The keypad automatically unlocks if an alarm or informational message occurs and remains unlocked while alarms are active.

5.3 Accessing the Standby Screen

1. After you press the  button, the Startup screen appears momentarily, indicating the device software version.
2. The Standby screen then appears, shown here. It displays the date and time, therapy mode, a patient accessory panel (if a patient accessory is attached), a status panel, and the soft key panel.

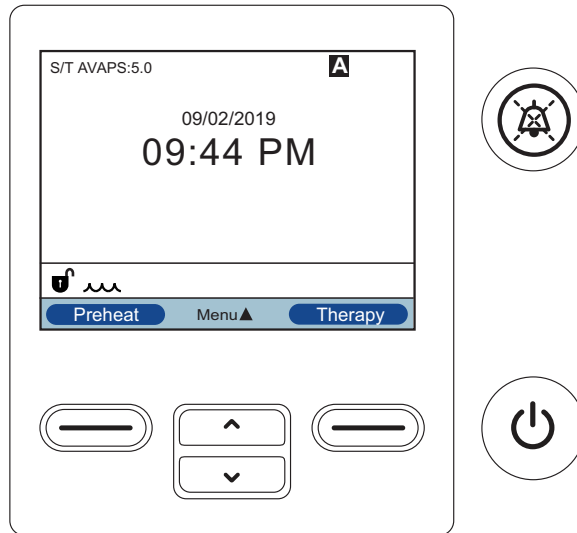

3. You can perform the following actions from the Standby screen :
 - a. If a humidifier is connected, you can activate the humidifier preheat function by pressing the Left (Preheat) key. See the Accessories chapter for more information.
 - b. If an accessory module is attached, you can monitor the connection to any attached patient accessory.
 - c. Access the menu by selecting the Up (Menu) key.
 - d. Initiate therapy by selecting the Right (Therapy) key. Selecting this key starts the airflow and displays the Monitoring screen.

5.4 Accessing the Setup Screen

- There are two ways to access the Setup screen:
 - Select Menu from the Standby screen
 - Perform the Provider Menu Access Key Sequence from the Standby screen
- You can access the device and therapy settings from this screen. The menu options vary based on your device setup. Sample screens are shown here.

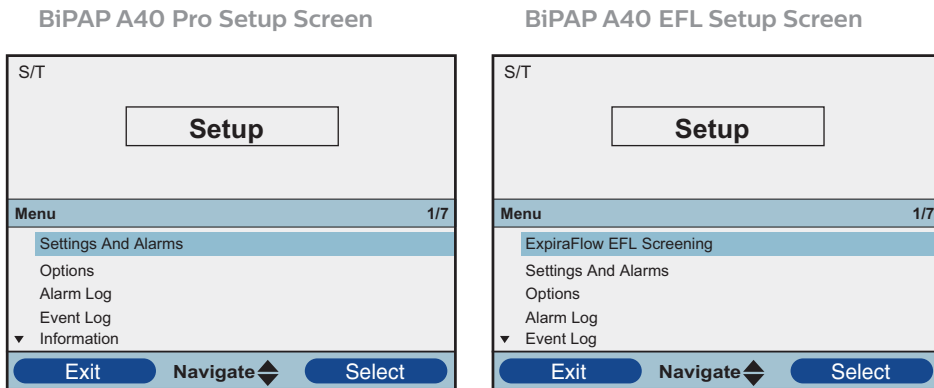

5.5 Accessing the Monitor Screen

The Monitor screen appears after you press the Therapy key on the Standby screen. There are two versions of this screen: Simple View and Detailed View. Samples of both screens are shown below.

5.5.1 Monitor Screen Content

The Monitor screen is divided into several panels, the Monitor panel, Date and Time panel, Patient Accessory panel (if attached), and the Status panel.

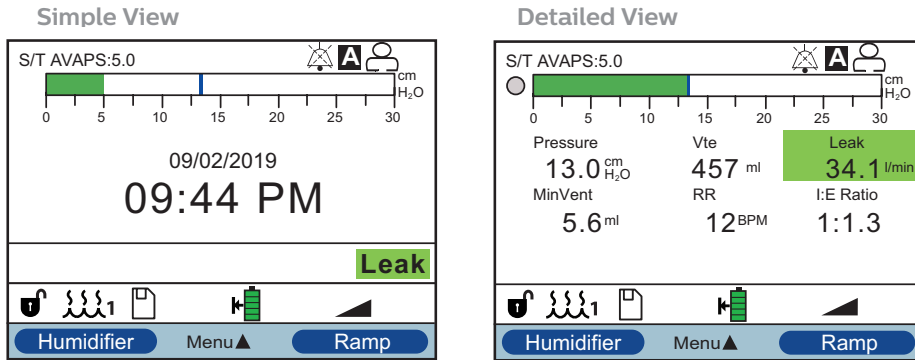

In Simple View, the Monitor screen displays the following:

1. Monitor Panel
 - a. Therapy mode
 - b. Flex or AVAPS (if enabled), display next to the therapy mode, along with the value setting
 - c. Patient breath indicator displays below the therapy mode
 - d. Peak pressure symbol appears on the graph according to the maximum Patient Pressure reached during each breath
 - e. A bar graph displays the current pressure level
 - f. If enabled, alarm status indicators for Audio Pause, Apnea, and Circuit Disconnect display in the upper right corner

2. The Date/Time panel shows the current date and time.
3. The Patient Accessory panel displays when an accessory is connected to the device. See the Accessories chapter for more information.
4. The Status panel displays certain symbols that indicate features being used, such as Ramp, as well as battery status.

In Detailed View in BiPAP A40 Pro, the same information is shown, except instead of displaying the Date and Time panel, the screen displays the following measured parameters:

- Patient Pressure
- Exhaled Tidal Volume
- Leak
- Minute Ventilation
- Respiratory Rate
- I:E Ratio

Note: When an oximeter is connected, the current SpO₂ and Heart Rate readings will only display on the Patient Accessory panel if Detailed View is turned on. When Detailed View is turned off, only a heart icon displays to indicate that the oximeter is connected and show the data status. The data values will not display.

5.5.2 Visual Leak

Visual Leak displays on the Monitor screen and includes the leak status and the actual leak value. The BiPAP A40 Pro and BiPAP A40 EFL devices include the following visual leak states:

- Acceptable leak - 
- Large leak - 
- Excessive leak and Low Leak - 

Note: The Leak parameter displays the measured total circuit leak in a color coded field. Leak value (l/min) is determined and updated with each breath. Refer to Chapter 6 for information on reading the Leak parameter display.

5.5.3 BiPAP A40 EFL with ExpiraFlow enabled

With ExpiraFlow screening enabled, the Detailed View screen displays the following measured parameters in addition to those listed above:

- ΔXrs value
- % Flow Limitation
- Respiratory system resistance (R_{total})

ExpiraFlow Enabled Simple View

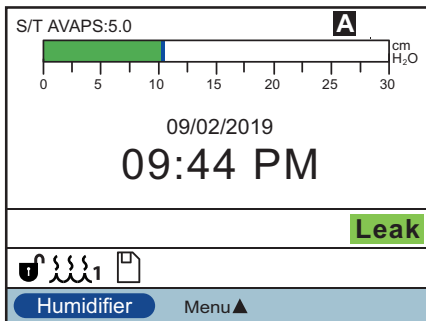

ExpiraFlow Enabled Detailed View

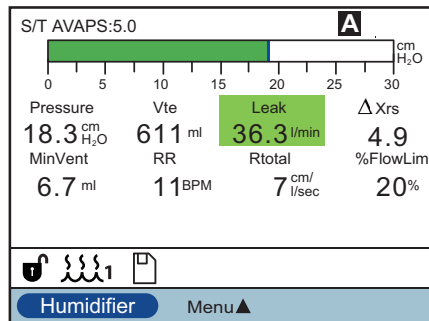

5.6 Changing Settings in Provider Menu Access Mode

1. Press the Up key to enter the Menu screens from the Standby or Monitor screens. The Main Menu screen appears.
2. Choose from the following selections on the Main Menu screen:
 - ExpiraFlow Screening (available in BiPAP A40 EFL only): the screening testing process to calculate the degree of prevalence of the Expiratory Flow Limitation measurement through tidal breathing calculated as ΔXrs values at 3 cm H₂O at 5 Hz with an amplitude of 2 cm H₂O.
 - Safely Remove SD Card: This option will appear if an SD card is inserted in the ventilator. Select this option when you want to remove the SD card. When the “Remove SD Card” confirmation message appears, remove the card. If you press the left (cancel) button or don't remove the card within 30 seconds, the confirmation message will close and the ventilator will continue writing to the card.

- Settings and Alarms: View and change prescription settings and alarms.
- Options: View and change device settings, such as Full or Limited Access mode, Detailed View, Language, etc.
- Alarm Log: View a list of the 20 most recent alarms that have occurred.
- Event Log: View a list of all events that have occurred, such as ventilator setting changes, ventilator inoperative conditions, alarms, etc.
- Information: View detailed information about the device, such as the device's software version and serial number.
- Write Event Log to SD Card: In Full Access mode with an SD Card installed, this option allows the user to write the Event Log to the SD Card for analysis.
- Clear Patient Data: This option appears on the Setup screen, when the airflow is off and the device is in Standby. It allows you to clear all patient data stored in the device memory and the device SD Card, if inserted. It also clears the Modem SD Card data. However, this will not clear the alarm log. The alarm log must be cleared separately.

5.6.1 Changing Device Settings and Alarms

1. From the Main Menu screen, use the Up/Down key to highlight the Settings and Alarms item.
2. Press the Right key to select Settings and Alarms.

The device settings are listed below, along with the therapy modes in which they are available. The following settings are common to all therapy modes:

- Therapy Mode
- Ramp Length
- System One Humidification
- Humidifier
- Tubing Type Lock
- Tubing Type
- System One Resistance Lock
- System One Resistance
- Circuit Disconnect
- Apnea
- Low Minute Ventilation
- High Respiratory Rate

5.6.2 Therapy Settings and Modes (BiPAP A40 Pro)

The settings below are specific to the BiPAP A40 Pro therapy modes.

	BiPAP A40 Pro Therapy Modes					
	CPAP	S	S/T	PC	T	AVAPS-AE
Mode	X	X	X	X	X	X
Trigger Type	X	X	X	X		X
Flow Trigger Sensitivity (available if Trigger type is Flow Trigger)	X	X	X	X		X
Flow Cycle Sensitivity (available if Trigger type is Flow Trigger)	X	X	X			X
Flex Lock		X				
Flex (not available if AVAPS is enabled)		X				
AVAPS		X (not available if Flex is enabled)	X	X	X	
AVAPS Rate *		X (available if AVAPS is enabled)	X (available if AVAPS is enabled)	X (available if AVAPS is enabled)	X (available if AVAPS is enabled)	X
Tidal Volume		X (available if AVAPS is enabled)	X (available if AVAPS is enabled)	X (available if AVAPS is enabled)	X (available if AVAPS is enabled)	X
AAM		X	X	X	X	
Max Pressure *		X (available if AVAPS and AAM are enabled)	X (available if AVAPS and AAM are enabled)	X (available if AVAPS and AAM are enabled)	X (available if AVAPS and AAM are enabled)	X
Pressure Support * (available if AAM is enabled)		X	X	X	X	
Pressure Support Max *		X (available if AVAPS and AAM are enabled)	X (available if AVAPS and AAM are enabled)	X (available if AVAPS and AAM are enabled)	X (available if AVAPS and AAM are enabled)	X

	BiPAP A40 Pro Therapy Modes					
	CPAP	S	S/T	PC	T	AVAPS-AE
Pressure Support Min *		X (available if AVAPS and AAM are enabled)	X (available if AVAPS and AAM are enabled)	X (available if AVAPS and AAM are enabled)	X (available if AVAPS and AAM are enabled)	X
IPAP * (not available if AVAPS enabled)		X	X	X	X	
IPAP Max Pressure * (available if AVAPS is enabled)		X	X	X	X	
IPAP Min Pressure * (available if AVAPS is enabled)		X	X	X	X	
EPAP * (not available if AAM is enabled)		X	X	X	X	
EPAP Max Pressure *		X (available if AAM is enabled)	X (available if AAM is enabled)	X (available if AAM is enabled)	X (available if AAM is enabled)	X
EPAP Min Pressure *		X (available if AAM is enabled)	X (available if AAM is enabled)	X (available if AAM is enabled)	X (available if AAM is enabled)	X
Breath Rate			X	X	X	X
Inspiratory Time			X	X	X	X (available if Breath Rate not "O" or Auto)
Rise Time Lock		X (available if Flex is not active)	X	X	X	X
Rise Time		X (available if Flex is not active)	X	X	X	X
Ramp Length	X	X	X	X	X	X
Ramp Start Pressure* (prescription dependent if ramp function available)	X	X	X	X	X	

	BiPAP A40 Pro Therapy Modes					
	CPAP	S	S/T	PC	T	AVAPS-AE
Heated Tube Humidification (available if heated tube is available)	X	X	X	X	X	X
Humidity Level (available if heated tube is available and enabled)	X	X	X	X	X	X
Tube Temperature (available if heated tube is available and enabled)	X	X	X	X	X	X
System One Humidification (available if heated tube is disabled or not available)	X	X	X	X	X	X
Humidifier (available if heated tube is disabled or not available)	X	X	X	X	X	X
Tubing Type Lock	X	X	X	X	X	X
Tubing Type (available if heated tube is disabled or not available)	X	X	X	X	X	X
System One Resistance Lock	X	X	X	X	X	X
System One Resistance	X	X	X	X	X	X
Circuit Disconnect Alarm	X	X	X	X	X	X
Apnea Alarm	X	X	X	X	X	X
Low Tidal Volume Alarm		X (available if AVAPS enabled)	X (available if AVAPS enabled)	X (available if AVAPS enabled)	X (available if AVAPS enabled)	X
Low Minute Ventilation Alarm	X	X	X	X	X	X
High Respiratory Rate Alarm	X	X	X	X	X	X
Low SpO ₂ Alarm (if pulse oximeter is connected)	X	X	X	X	X	X

* Indicates pressure increments are 0.5 cm H₂O res. Note: "Res" stands for resolution, which is the incremental value for that setting.

5.6.3 Therapy Settings and Modes (BiPAP A40 EFL)

The settings below are specific to the BiPAP A40 RFL therapy modes.

	BiPAP A40 EFL Therapy Modes			
	CPAP	S	S/T	PC
Mode	X	X	X	X
Trigger Type	X	X	X	X
Flow Trigger Sensitivity (available if Trigger type is Flow Trigger)	X	X	X	X
Flow Cycle Sensitivity (available if Trigger type is Flow Trigger)	X	X	X	
Flex Lock		X		
Flex (not available if AVAPS is enabled)		X		
ExpiraFlow (not available if AAM is enabled)		X	X	X
Bacteria Filter (available if ExpiraFlow is enabled)		X	X	X
AVAPS		X	X	X
AVAPS Rate * (available if AVAPS is enabled)		X	X	X
Tidal Volume (available if AVAPS is enabled)		X	X	X
AAM (not available if ExpiraFlow is enabled)		X	X	X
Max Pressure * (available if AVAPS and AAM are enabled)		X	X	X
Pressure Support * (available if AAM is enabled)		X	X	X
Pressure Support Max * (available if AVAPS and AAM are enabled)		X	X	X
Pressure Support Min * (available if AVAPS and AAM are enabled)		X	X	X
CPAP *	X			
IPAP * (not available if AVAPS enabled)		X	X	X

	BiPAP A40 EFL Therapy Modes			
	CPAP	S	S/T	PC
IPAP Max Pressure * (available if AVAPS is enabled)		X	X	X
IPAP Min Pressure * (available if AVAPS is enabled)		X	X	X
EPAP * (not available if AAM is enabled)		X	X	X
EPAP Max Pressure * (available if AAM is enabled)		X	X	X
EPAP Min Pressure * (available if AAM is enabled)		X	X	X
Breath Rate			X	X
Inspiratory Time			X	X
Rise Time Lock		X (available if Flex is not active)	X	X
Rise Time		X (available if Flex is not active)	X	X
Ramp Length (not available if ExpiraFlow is enabled)	X	X	X	X
Ramp Start Pressure * (prescription dependent if ramp function available)	X	X	X	X
Heated Tube Humidification (available if heated tube is available)	X	X	X	X
Humidity Level (available if heated tube is available and enabled)	X	X	X	X
Tube Temperature (available if heated tube is available and enabled)	X	X	X	X
System One Humidification (available if heated tube is disabled or not available)	X	X	X	X
Humidifier (available if heated tube is disabled or not available)	X	X	X	X
Tubing Type Lock	X	X	X	X

	BiPAP A40 EFL Therapy Modes			
	CPAP	S	S/T	PC
Tubing Type (available if heated tube is disabled or not available)	X	X	X	X
System One Resistance Lock (not available if ExpiraFlow is enabled)	X	X	X	X
System One Resistance (not available if ExpiraFlow is enabled)	X	X	X	X
Circuit Disconnect Alarm	X	X	X	X
Apnea Alarm	X	X	X	X
Low Tidal Volume Alarm (available if AVAPS enabled)		X	X	X
Low Minute Ventilation Alarm	X	X	X	X
High Respiratory Rate Alarm	X	X	X	X
Low SpO ₂ Alarm (available if pulse oximeter is connected)	X	X	X	X

* Indicates pressure increments are 0.5 cm H₂O res. Note: “Res” stands for resolution, which is the incremental value for that setting.

5.6.4 Therapy Settings

Mode

Change the Mode setting to one of the following therapy modes:

- CPAP
- S
- S/T
- T (BiPAP A40 Pro only)
- PC
- AVAPS-AE (BiPAP A40 Pro only)

Trigger Type

The device can be set to trigger breaths based on automatic flow thresholds or specific flow settings. Change the Trigger Type to one of the following options: **Auto-Trak**, **Auto-Trak [Sensitive]** or **Flow Trigger**. Auto-Trak is the Trigger Type default.

If Flow Trigger is selected then two set points will be available for adjustment: Flow Trigger Sensitivity and Flow Cycle Sensitivity.

- **Flow Trigger Sensitivity (Expiration to Inspiration)**
The Flow Trigger Sensitivity may be adjusted from 1 to 9 l/min in 1 l/min increments. The flow trigger initiates when the patient's inspiratory effort creates a flow equal to or greater than the flow sensitivity setting.
- **Flow Cycle Sensitivity (Inspiration to Expiration)**
The Flow Cycle Sensitivity may be adjusted from 10 to 90% in 1% increments. As flow begins to decrease during inspiration, if the patient flow is less than the flow cycle set point, the device will cycle to expiration.

CPAP

Increase or decrease the CPAP pressure setting from 4 to 20 cm H₂O in increments of 0.5.

Flex Lock

Select Off to allow users to adjust the Flex setting (in S mode only). Or, select On so users cannot adjust their Flex setting.

Flex

This setting is only available in S mode, but is not available if AVAPS is enabled. Set Flex to 1, 2, or 3 to enable the setting. A setting of 1 provides a small amount of pressure relief, with higher numbers providing additional relief. Select Off to disable the setting. The patient also has access to this setting, if Flex Lock is off. However, if Flex is “Off”, the user cannot adjust it.

ExpiraFlow (BiPAP A40 EFL only)

Select On or Off to enable or disable ExpiraFlow.

AVAPS

Select On or Off to enable or disable AVAPS.

AVAPS Rate

If AVAPS is enabled, the AVAPS Rate may be adjusted from 0.5 to 5.0 cm H₂O/minute in 0.5 cm H₂O increments.

Tidal Volume

If AVAPS is enabled (or in AVAPS-AE mode), you can adjust the target tidal volume from 200 to 1500 ml in 10 ml increments.

AAM

Select On or Off to enable or disable AAM.

IPAP

This setting displays if AVAPS is Off. Increase or decrease the Inspiratory Positive Airway Pressure (IPAP) from 4 to 40 cm H₂O in increments of 0.5. You cannot set the IPAP setting lower than the EPAP setting. IPAP is limited to 25 cm H₂O when the Flex feature is enabled.

IPAP Max Pressure

This setting displays if AVAPS is enabled. Increase or decrease the setting from 4 to 40 cm H₂O in increments of 0.5. The IPAP Max Pressure must be equal to or greater than the IPAP Min value.

IPAP Min Pressure

This setting displays if AVAPS is enabled. Increase or decrease the setting from 4 to 40 cm H₂O in increments of 0.5. The IPAP Min Pressure must be equal to or greater than the EPAP value, and it must be less than or equal to the IPAP Max Pressure.

EPAP

Increase or decrease the Expiratory Positive Airway Pressure (EPAP) from 4 to 25 cm H₂O in increments of 0.5.

Breath Rate

Use the Breath Rate setting to establish the minimum rate of mandatory breaths that the ventilator will deliver per minute. Increase or decrease the Breath Rate setting in increments of 1, as follows:

- S/T and PC modes: from 0 to 40 BPM
- T mode: from 4 to 40 BPM
- AVAPS-AE mode: 0 or Off, Auto, 1 to 40 BPM

Note: A Mandatory breath (or machine breath) is a ventilator-initiated, time-cycled breath. The ventilator controls both the beginning (triggering) and end (cycling) of the inspiratory phase.

Inspiratory Time

Adjust the Inspiratory Time setting from 0.5 to 3.0 seconds in 0.1 second increments. Inspiratory Time is the duration for the inspiratory phase of a mandatory breath.

Maximum Pressure

This setting displays in AVAPS-AE mode or if AVAPS is enabled. AVAPS-AE limits the pressure delivery to the Maximum Pressure setting. Increase or decrease the setting from 6 to 40 cm H₂O in increments of 0.5 cm H₂O.

Pressure Support Max

This setting displays in AVAPS-AE mode or if AVAPS is enabled. Increase or decrease the setting from 2 to 36 cm H₂O in increments of 0.5 cm H₂O. The Pressure Support Max Pressure must be equal to or greater than the Pressure Support Min value.

Pressure Support Min

This setting displays in AVAPS-AE mode or if AVAPS is enabled. Increase or decrease the setting from 2 to 36 cm H₂O in increments of 0.5 cm H₂O. The Pressure Support Min Pressure must be less than or equal to the Pressure Support Max value cm H₂O.

EPAP Max Pressure

This setting displays in AVAPS-AE mode or if ExpiraFlow or AAM is enabled. Increase or decrease the setting from 4 to 25 cm H₂O in increments of 0.5 cm H₂O. The EPAP Max pressure settings must be equal to or greater than the EPAP Min Pressure value.

EPAP Min Pressure

This setting displays in AVAPS-AE mode or if ExpiraFlow or AAM is enabled. Increase or decrease the setting from 4 to 25 cm H₂O in increments of 0.5 cm H₂O. The EPAP Min Pressure must be less than or equal to the EPAP Max value.

Rise Time Lock

Select Off to allow users to adjust their Rise Time setting or On to prevent users from adjusting the setting.

Rise Time

Adjust the rise time from 1 to 6 to find the most comfortable setting for the patient. Rise time is the time it takes for the device to change from EPAP to IPAP when the breath is triggered. A rise time setting of 1 is the fastest, while a rise time setting of 6 is the slowest. The patient also has access to this setting if Rise Time Lock is turned off.

Ramp Length

Disable Ramp by selecting Off, or increase or decrease the Ramp Length setting from 5 to 45 minutes in 5-minute increments. When you set the ramp length, the device increases the pressure from the value set on the Ramp Start Pressure screen to the pressure setting over the length of time specified here.

Note: Ramp is not available when ExpiraFlow therapy is enabled.

Ramp Start Pressure

This setting displays in CPAP, S, S/T, PC, or T modes. Increase or decrease the ramp start pressure in increments of 0.5 from 4 cm H₂O to the pressure setting. The patient also has access to this setting, unless the ramp length is set to Off.

Note: Ramp is not available when ExpiraFlow therapy is enabled.

Heated Tube Humidification

This setting will only display if you are using the heated tube. You can enable (On) or disable (Off) this feature.

Humidity Level

This setting will only display if you are using the heated tube. This setting allows you to choose the desired humidity setting for the humidifier: 0, 1, 2, 3, 4 or 5.

Tube Temperature

This setting will only display if you are using the heated tube. This setting allows you to choose the desired temperature for the heated tube: 0, 1, 2, 3, 4 or 5. If you choose zero (0), this will turn off both the humidifier and the heated tube.

Note: When using Heated Tubing, use the Left button while the blower is running and the Monitoring Screen is active to change this setting.

System One Humidification

Select On to enable or Off to disable this humidification feature. System One humidity control maintains a consistent mask humidity by monitoring and adjusting for changes in room temperature and room humidity.

Note: The System One Humidification option is only available if the Heated Tubing is removed or has been disabled.

Humidifier

Increase or decrease this setting from 0-5 in increments of 1. When the setting is 0, the humidifier is off. 0 is the lowest humidity setting while 5 is the highest setting. Please refer to the humidifier manual if using a humidifier.

Note: The Humidifier option is only available if the Heated Tubing is removed or has been disabled.

Tubing Type Lock

Select Off to allow users to change the tubing type in user mode. Or, select On so users cannot adjust their tubing type.

Tubing Type

This setting allows you to select the correct size diameter tubing that you are using with the device. Select 22 mm for the Philips Respironics 22 mm tubing, or 15 mm for the optional Philips Respironics 15 mm (standard or heated) tubing. The patient also has access to this setting if Tubing Type Lock is off. When using Heated Tubing, the device will automatically change this setting to the appropriate tubing type (15H) and you will not be able to change it.

Note: *If the Heated Tubing is removed, the device will default back to the previous tubing type setting.*

Warning: *If you are using the optional Philips Respironics 15 mm tubing, the device tubing type setting must be set to 15. If your device does not have the tubing type setting, you must use the Philips Respironics 22 mm tubing selection.*

System One Resistance Lock

Select Off to allow users to modify the System One resistance setting. Or, select On so users cannot adjust their System One resistance. Not available if ExpiraFlow is enabled.

System One Resistance

Select from 0-5 to set the System One resistance. Choose “0” to turn System One Resistance compensation off. This setting allows you to adjust the level of resistance based on the specific Philips Respironics mask. Each Philips Respironics mask may have a “System One” Resistance control setting. The patient also has access to this setting if System One Resistance Lock is off. Not available if ExpiraFlow is enabled.

Note: *There is also an “invasive” setting available in BiPAP A40 Pro.*

Circuit Disconnect Alarm

This setting enables or disables the circuit disconnect alarm. If enabled, an audible alarm will sound when a large, continuous air leak (such as mask removal) has been detected in the circuit.

Select Off to disable the alarm. Or, choose 15 or 60 seconds. Selecting 15 or 60 means that the alarm will sound after the circuit has been disconnected for that amount of time.

Apnea Alarm

This setting enables or disables the apnea alarm. If enabled, an audible alarm will sound when an apnea is detected.

Select Off to disable the alarm. Or, increase or decrease the setting from 10 to 30 seconds in 10 second increments. For example, a setting of 10 means that the alarm will sound if the time between spontaneous breaths exceeds 10 seconds.

Low Tidal Volume Alarm

Select On to enable or Off to disable the Low Tidal Volume alarm. When the alarm is enabled, an audible indicator sounds if target tidal volume can't be reached. This alarm is only available when AVAPS is enabled (or AVAPS-AE in BiPAP A40 Pro).

Low Minute Ventilation Alarm

This setting enables or disables the Low Minute Ventilation alarm. The alarm activates when the calculated minute ventilation is less than or equal to this setting. Select Off to disable this alarm, or increase or decrease the setting from 1 l/min to 99 l/min in increments of 1.

High Respiratory Rate Alarm

This setting enables or disables the High Respiratory Rate alarm. The alarm activates when the measured respiratory rate reaches or exceeds this setting. Select Off to disable this alarm, or increase or decrease the setting from 4 BPM to 60 BPM in increments of 1.

Low SpO₂ Alarm

This setting enables or disables the Low SpO₂ Alarm. If enabled, an audible alarm will sound when the measured SpO₂ is less than the Low SpO₂ setting while the device is delivering therapy. The default setting is at 85%. Select Off to disable the alarm, or increase or decrease the setting from 50% to 95% in increments of 1.

5.6.5 Changing Options Menu Settings

1. From the Main Menu screen, use the Up/Down key to highlight the Options item.
2. Press the Right key to select Options.

Options Settings

The following settings are available on the Options menu.

Menu Access

Select Full or Limited menu access. Full menu access allows home care equipment providers to access all ventilator and prescription settings. Limited menu access allows users to access only certain settings and does not allow them to change prescription settings.

Detailed View

Turn Detailed View On or Off using this setting. Detailed view displays additional therapy information on the Monitor screen.

Language

Select the Language that the software will appear in (English, French, German, etc.). The information on the screens will display in the language selected here.

Pressure Units

Select the pressure units that will display on the screens. You can choose either cm H₂O or hPa. All pressure units on the screens will display in the unit of measure selected here.

Breath Indicator

Select Patient or Machine to choose whether the breath indicator flashes on-screen during a patient-triggered breath or a machine-triggered breath. The default is Machine.

Keypad Lock

Select On to enable or Off to disable the Keypad Lock feature.

Keypad Backlight

Turn the backlight On or Off using this setting. Whenever you press the  button to begin therapy, the keypad backlight temporarily lights up. Once therapy is being provided, the keypad will be lit according to this Keypad Backlight setting. If the setting is On, the backlight remains on while therapy is provided. If the setting is Off, the backlight remains off while therapy is provided.

Note: *The Keypad Backlight setting does not turn the Start/Stop button on or off.*

LCD Brightness

Adjust the brightness of the screen backlight from 1 – 10, with 1 being the dimmest setting and 10 being the brightest.

Screen Saver

You can change the screen saver to reduce power consumption or dim the screen in a dark room. The following settings are available:

- Dim: The display's backlight is decreased, so that the display is still visible but not as bright.
- Breath: The display appears as a black screen, with only the patient breath indicator and manometer visible.
- Off: No screen saver displays and the display's backlight remains lit.

If enabled, the screen saver displays after 5 minutes of no keypad activity. Pressing any button on the device will exit the screen saver. Additionally, any alarm or informational message will also exit the screen saver.

Date Format

Select either mm/dd/yyyy or dd/mm/yyyy as the date format that will display on the device screens.

Time Format

Select either an AM/PM time format (hh:mm AM) or 24 Hour time format (hh:mm)
For example, 2:49 PM or 14:49.

Month

The month defaults to the current month. The adjustable range is from 1 (January) – 12 (December).

Day

The day defaults to the current day. The adjustable range is from 1 – 31. The maximum value is based on the selected month.

Year

The year defaults to the current year. The adjustable range is from 2000 – 2069.

Hour

The adjustable range is from 1 AM/PM – 12 AM/PM or 0-23, depending on the selected Time Format.

Minute

The minute defaults to the current minute. The adjustable range is from 0 – 59.

Blower Hours

Displays the number of hours that the blower has been active since the last time this value was reset.

Note: *The Machine Hours displayed on the Information screen indicates the total number of hours that the blower has been working over the life of the device. This value cannot be reset.*

Therapy Hours

This setting displays the total time the patient receives therapy. This value can not be reset. You can reset this value to zero if desired (e.g., each time you give the device to a new patient)

5.6.6 Viewing the Alarm Log

1. From the Main Menu screen, use the Up/Down key to highlight the Alarm Log item.
2. Press the Right key to select Alarm Log.

The alarm log displays the alarms in chronological order with the most recent events displayed first. It lists the 20 most recent alarms or messages that appeared on the device display.

The alarm log can be cleared when in Full Menu access mode, but not when the device is in Limited Menu access mode. Press the Right (Clear) key to clear the alarm log.

Note: Depending on how many alarms have occurred, the alarm log may be up to 4 pages long.

5.6.7 Viewing the Event Log

1. From the Main Menu screen, use the Up/Down key to highlight the Event Log item.
2. Press the Right key to select Event Log.

The event log displays a list of all events that have occurred, in chronological order with the most recent events displayed first. The event log is available in Full Menu access mode but not in Limited Menu access mode.

3. If desired, press the Right (Clear) key to clear the event log.

5.6.8 Viewing Device Information

1. From the Main Menu screen, use the Up/Down key to highlight the Information item.
2. Press the Right key to select Information.

The Information screen provides you with a summary of the current prescription settings, device settings, and system settings. You can use the Up/Down buttons to scroll through the information.

You can also view the Information screen by holding the **Down** key for 5 seconds when in the Monitor screen. This causes the detailed view of the Monitor Screen and the Information Screen to be displayed temporarily.

5.7 Updating Prescriptions Using the SD Card

You can update the patient's prescription using the SD Card. The prescription update can occur either when the ventilator is off or on.

1. Insert an SD Card with a valid prescription into the device. A “**Change Prescription?**” message appears on the display.
2. Select **Yes** to start the prescription update process. Select **No** to cancel the prescription update process and return to the previous display.
3. Select **Page** to review the entire prescription. Select **Cancel** to cancel the prescription update process and return the screen to the initial state before the prescription update started.
4. Once the entire prescription has been reviewed, a screen displays with the option to Cancel or OK the changes. Select **OK** to complete the prescription update and display the Prescription Change confirmation screen. Select **Cancel** to cancel the prescription update process and return the screen to the initial state before the prescription update started.

If the SD card is removed at any time during the prescription update, the process aborts and the screen returns to the initial state before the prescription update started.

A message appears on the display if errors occur during this process. For details on the possible prescription errors, refer to Chapter 9, Troubleshooting.

5.8 Changing Settings in Limited Menu Access Mode

The settings available to users are limited when the device is set to Limited access mode.

1. Press the Up key to enter the Menu screens from the Standby or Monitor screens. The Main Menu screen appears.
2. Choose from the following selections on the Main Menu screen:
 - Safely Remove SD Card: This option appears if an SD card is inserted in the ventilator. Select this option when you want to remove the SD card. When the “Remove SD Card” confirmation message appears, remove the card. If you press the Left (Cancel) button or don’t remove the card within 30 seconds, the confirmation message will close and the ventilator will continue writing to the card.
 - My Settings: View and change certain prescription settings, such as rise time or ramp starting pressure, if these settings were enabled by your provider.
 - Options: View and change certain device settings, such as keypad lock or keypad backlighting.
 - Alarm Log: View a list of the 20 most recent alarms that have occurred.
 - Information: View detailed information about your device, such as the device’s software version and serial number.

5.8.1 Changing My Settings Menu Items

1. From the Main Menu screen, use the Up/Down key to highlight the My Settings item.
2. Press the Right key to select My Settings. The My Settings screen will appear.

Follow the general instructions below to navigate and change any of the therapy settings.

1. From the My Settings screen, use the Up/Down button to navigate to the setting you want to change and highlight it.
2. To modify a setting once it is highlighted, press the Right (Modify) button.

3. Use the Up/Down (Edit) button to scroll through the available settings. Press Down to decrease the setting, or press Up to increase the setting.
4. Once you have chosen the setting you want, press the Right (OK) button to save the new setting. Or, if you decide not to change the setting, press the Left (Cancel) button.
5. You can now either navigate to the next setting you want to change using the Up/Down (Navigate) button, or exit the My Settings menu by pressing the Left (Finish) button to return to the Main Menu.

You can change the following settings in the My Settings menu, if they are enabled by your home care equipment provider. Refer to the Therapy Settings section earlier in this chapter for details about each setting.

- Tubing Type
- Rise Time
- Ramp Start Pressure
- Flex
- System One Resistance
- Humidifier

5.8.2 Options Menu Items in Limited Access Mode















The following settings are included in the Options menu when the device is in Limited access mode. Refer to the Options Settings section earlier in this chapter for details on each setting.









- Keypad Lock
- Keypad Backlight
- LCD Brightness
- Screen Saver
- Date Format
- Time Format
- Month
- Day
- Year
- Hour
- Minute

5.9 Display Symbols

The following table defines symbols that may appear on-screen.

Symbol	Description
	Apnea alarm enabled
AVAPS: 1	AVAPS enabled, and the AVAPS rate setting (e.g., 1)
	Audio Pause is active
	Circuit Disconnect alarm is enabled
	High quality data is detected (flashing symbol). The oximetry module and pulse oximeter sensor are attached to the therapy device correctly.
	The oximetry module or pulse oximeter sensor is not functioning correctly. Reposition to achieve a high quality data symbol. Contact your home care equipment provider if this symbol is consistently displayed on the therapy device's display.
	Session Complete - A session is defined as at least 4 hours of high quality data have been collected.
HR	Heart Rate - The pulse rate measured in Beats Per Minute.
SpO₂	Oxygen Saturation - The measurement of functional oxygen saturation of arterial hemoglobin (%SpO ₂).
Δ Xrs	The difference between the mean value of Xrs during expiration and the mean value of Xrs during inspiration.
FLEX: 1	FLEX enabled and FLEX setting (e.g., 1)
	Full Menu Access Mode (Provider mode)
	Humidifier is connected and Humidifier setting (e.g., 1)
	Humidifier is active and Humidifier setting (e.g., 1)
	Bad humidifier state (flashing symbol displays)
	Heated tube is connected and Tube Temperature setting (e.g., 1)

Symbol	Description
	Heated tube is active and Tube Temperature setting (e.g., 1)
	Bad heated tube state (flashing symbol displays)
	Ramp
	SD Card Inserted
	SD Card Error (Bad memory card inserted)
	Writing to SD Card
	External Battery in use and full capacity
	External Battery in use and at 80% capacity
	External Battery in use and at 60% capacity
	External Battery in use and at 40% capacity
	External Battery in use and at 20% capacity
	External Battery in use and has less than 20 minutes
	External Battery in use and has less than 10 minutes
	External Battery 0 Minutes

	Capacity (while discharging)	Time Remaining Adult Therapy (while discharging)	Time Remaining Pediatric Therapy (while discharging)
	Detachable Battery in use. Capacity between 81% and 100%	550 Minutes to 710 Minutes	480 Minutes to 650 Minutes
	Detachable Battery in use. Capacity between 61% and 80%	400 Minutes to 550 Minutes	340 Minutes to 480 Minutes
	Detachable Battery in use. Capacity between 41% and 60%	260 Minutes to 400 Minutes	230 Minutes to 340 Minutes
	Detachable Battery in use. Capacity between 21% and 40%	120 Minutes to 260 Minutes	100 Minutes to 230 Minutes
	Detachable Battery in use. Capacity between 1% and 20%	20 Minutes to 120 Minutes	20 Minutes to 100 Minutes
	Detachable Battery in use. Capacity 0% (low priority alarm)	Less than 20 Minutes	Less than 20 Minutes
	Detachable Battery in use. Capacity 0% (high priority alarm)	Less than 10 Minutes	Less than 10 Minutes
	Detachable Battery Capacity 0%	0 Minutes	0 Minutes

Note: The detachable battery capacities above reflect the battery state while discharging.

Note: Refer to the instructions included with your detachable battery pack for descriptions of the detachable battery symbols that appear on-screen when the battery is installed in the device.

6. ExpiraFlow EFL Screening

6.1 ExpiraFlow Screening Mode (BiPAP A40 EFL only)

ExpiraFlow Screening is a five minute clinician's screening test to screen for the prevalence of Expiratory Flow Limitation (EFL) in COPD patients.

The ExpiraFlow Screening mode is not a therapy mode and is available only when therapy is not being administered.

ExpiraFlow Screening is to be conducted in a institutional/hospital setting, a physician examination office, or a diagnostic laboratory environment.

6.1.1 Prior to Active Screening

For best screening results, the patient should be placed in the supine position with one pillow to support their head for the complete five minute screening test. Be sure the mask is properly fitted to the patient before entering active screening mode and ensure that the patient is comfortable and patient leak is stable.

Note: Screening values may be monitored during the testing. If required by the patient, supplemental oxygen may be added during the testing. Supplemental oxygen values may also be monitored during testing.

6.1.2 Required Accessories

Important: Proper operation of the ventilator, including alarms, with other circuits has not been verified by Philips Respironics and is the responsibility of the health care professional or respiratory therapist.

The following are required accessories to assemble the interface and circuit system to be used with ExpiraFlow Screening:

Interface (non-invasive mask):

- Philips Respironics AF541 non-invasive ventilation (NIV) mask with Whisper Swivell II
- Philips Respironics Pico Nasal mask

Philips Respironics Bacteria filter:

- **REF** C06417 - Filter, Bacterial, Disposable (single)
- **REF** 342077 - Bacteria Filter Box 10
- **REF** C06418 - Filter, Bacterial, Disposable, Case of 50

Flexible tubing:

- **REF** 1032907 - Philips Respironics System One Performance Tubing 6 ft. (22mm)

6.1.3 Setting up the Patient

Important: Be sure to use required masks and accessories that are recommended by Philips Respironics. Using a mask or accessory other than those will render screening invalid.

The automated five minute screening test should be done in a clinical environment by a physician or clinician under the supervision of a physician.

1. Select the appropriate nasal or full face mask for the patient.
2. Fit and adjust the mask. Refer to the instructions that came with the mask.
3. It is preferred that the patient be screened in a supine position (face and torso up) with one pillow for comfort.

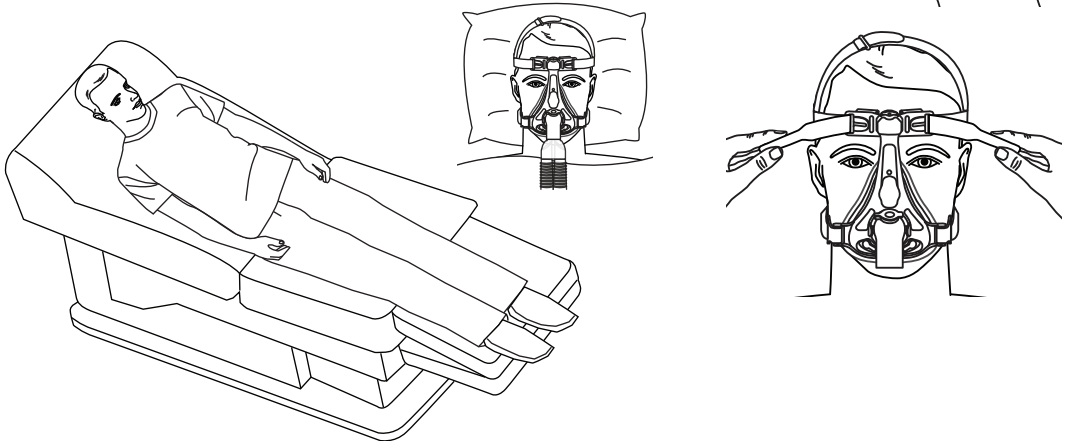

Important: A semi-recumbent position will be acceptable if supine position is not achievable.

6.2. Starting the ExpiraFlow Screening Test

1. Press the Up/Down keys to enter the Menu from the Standby or Monitor screens and navigate to ExpiraFlow EFL Screening.
2. Select the Right (Select) key.
3. Air flow begins at 4 cm H₂O (when the mask selection screen is displayed) and continues to deliver 4 cm H₂O after the screening process has ended.
4. Press the Up/Down keys to choose a mask.

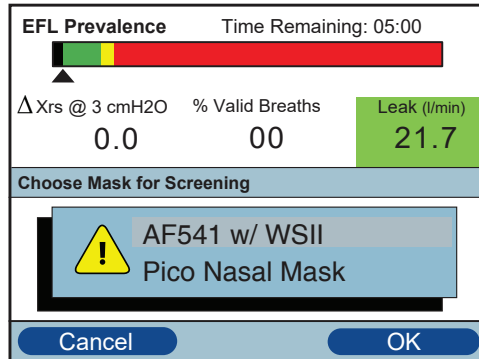

5. Select the Right (OK) key to confirm the mask choice. Choosing the Left (Cancel) key will exit the screening and return to the Standby Screen.
6. Be sure that the leak on the screen is within limits (green). If not, adjust the patient's mask accordingly.

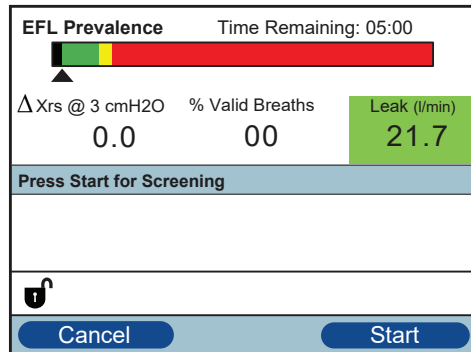

7. Select the Right (Start) key to start ExpiraFlow Screening. The screening process will begin at 3 cm H₂O with FOT (Forced Oscillation Technique) at 5 Hz with an amplitude of 2 cm H₂O.

Note: Screening values can be monitored during testing.

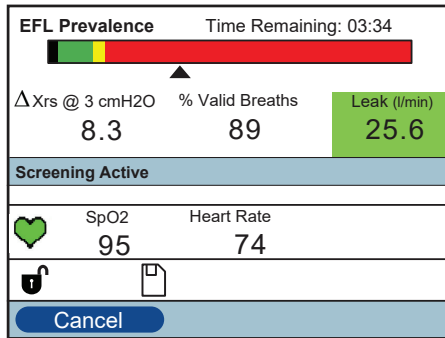

Note: The ventilator will deliver air flow before screening at 4 cm H₂O and continue to deliver 4 cm H₂O after the screening process has ended.

The screening process may be ended at any time by using the Left key to cancel. Results from the test will be deleted if cancelled. During screening, the Right key is hidden.

When screening is completed, a confirmation screen will display along with an audible indicator, showing the status of the screening process. Select OK to acknowledge the confirmation screen. The ventilator will return to the Standby Screen.

The screening test is valid when the percentage of valid breaths is 80% or greater.

Note: Screening can be canceled at any time and restarted.

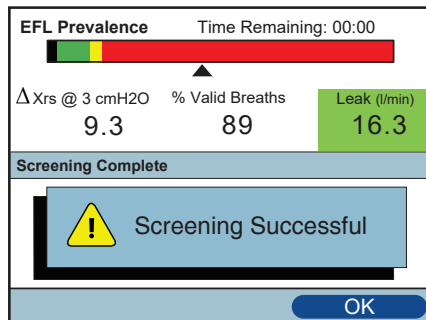

If the screening process has failed, the confirmation screen will indicate a reason for the failure. Select the Right (OK) key to acknowledge the confirmation screen. The ventilator will return to the Standby Screen.

If an alarm occurs during screening, the screening will continue. The alarm will display in the Menu Banner by the newest and the highest priority. Select the Left (Clear) key to acknowledge the alarm(s). The ventilator will return to the Standby Screen.

6.3 Reading Screening Information

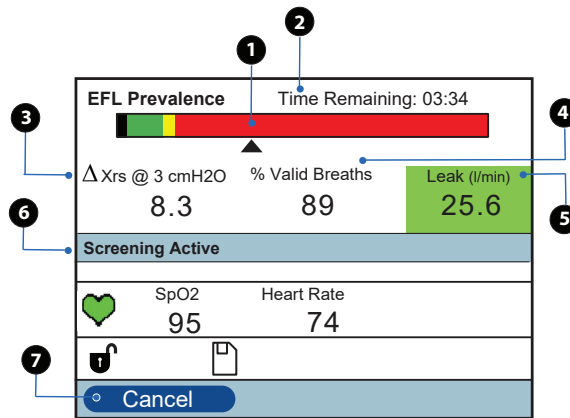

#	Feature	Description
1	EFL Prevalence	<p>Green No EFL is present at 3 cm H₂O</p> <p>Yellow EFL is present but indeterminate</p> <p>Red EFL is present</p> <p>Black No valid value</p>
2	Time Remaining	Screening starts at 5 minutes and counts down to zero, ending the test session.
3	ΔXrs value	<p>Index for the presence of Expiratory Flow Limitation in trial breathing. The ΔXrs value displayed during the screening session is the median of the last valid 20 breaths detected. Similarly, the final value displayed at the end of the screening session is the median of the final 20 valid breaths.</p> <ul style="list-style-type: none"> < 2.8 cm H₂O/l/s are not flow limited. Between 2.8 and 3.8 cm H₂O/l/s, inclusive, EFL is indeterminate. Some patient breaths were calculated to be flow limited. Greater than 3.8 cm H₂O/l/s are flow limited breaths and suggest further review.
4	Percentage of valid breaths	The total percentage of breaths that meet the screening criteria.
5	Leak value (l/min)	<p>The total circuit leak value is determined and updated with each breath.</p> <p>Green Leak value result is good</p> <p>Yellow Large leak value (leak amount is 75 percent of the circuit disconnect alarm)</p> <p>Amber Leak value is not sufficient to calculate EFL</p>
6	Menu Banner	Displays current status of the Screening process (including high, medium, and low priority alarms).
7	Cancel key	Screening process may be exited before completion and returned to the Standby Screen.

Note: Before testing begins, the therapy pressure setting point is 4 cm H₂O. The therapy pressure setting point during the Screening process is constant during testing with the Forced Oscillation Technique (FOT) at 5 Hz with amplitude of 2 cm H₂O. When testing is concluded, the ventilator will revert to the therapy pressure setting 4 cm H₂O.

Note: Screening results are only captured in the device data storage logs. However, only therapy results are sent to an external data management system.

Note: The ΔXrs value and percentage of valid breaths detail displayed from the last completed screening are stored following a successful screening.

6.3.1 Indicator and Description

Indicator	Description
EFL Prevalence	EFL Prevalence is the measured prevalence of the Expiratory (air) Flow Limitation during quiet breathing calculated as ΔXrs values at 3 cm H ₂ O with FOT at 5 Hz with an amplitude of 2 cm H ₂ O.
Prevalence Bar	Displays a graphic bar indicating the range of ΔXrs values. Areas of the Prevalence Bar are color-coded to indicate the presence and severity of EFL based on the ΔXrs value at 3 cm H ₂ O of patient applied pressure.
Prevalence Indicator	Positioned below the Prevalence Bar according to the current ΔXrs value, this arrow (▲) reflects the current computed ΔXrs value. Before screening starts, the Prevalence Indicator is positioned at the left-most portion of the black range. If the ΔXrs value cannot be calculated during screening, the Prevalence Indicator moves to the left-most portion of the black range until a valid value is calculated.
Time Remaining	Displays the time remaining for the current screening session. Screening starts at 5 minutes and counts down to zero, ending the test session. (XX:XX)
Alarm Status (Right)	Displays the icon for Audio Pause (🔇) if Audio Pause is active.
ΔXrs (Delta Xrs)	Displays the current ΔXrs value. Dashes display before screening is started and when the ΔXrs cannot be calculated. (---) ΔXrs is calculated at 3 cm H ₂ O with FOT at 5 Hz with an amplitude of 2 cm H ₂ O during screening.
% Valid Breaths	Displays the current percentage of valid breaths during the screening. No units are displayed. Dashes are displayed before screening is started until the first valid breath or four breaths have occurred. (---) Note: At least 80% of the breaths during screening must be valid for the screening to be considered valid. If the percentage of valid breaths during screening are less than 80%, the screening test will fail.
Leak	Displays the measured total circuit leak. The units (l/min) are displayed next to the label. (---.-)
FOT	Forced Oscillation Technique is a method to detect the presence of expiratory flow limitation at 5 Hz with amplitude of 2 cm H ₂ O.
Quiet Breathing	This is a mode of breathing that occurs at rest and does not require the cognitive thought of the individual.

7. Cleaning, Disinfection, Service

7.1 Cleaning and Disinfection Overview

	Home cleaning	Home Disinfection	Hospital Cleaning	Hospital Disinfection
Ventilator Exterior	mild liquid dishwashing detergent and water, weekly	70% Isopropyl Alcohol if available, cloth with chlorine bleach (8.3% sodium hypochlorite), 1 to 10 part reduction in water weekly	mild liquid dishwashing detergent and water, weekly and between patients	70% Isopropyl Alcohol cloth with chlorine bleach (8.3% sodium hypochlorite), 1 to 10 part reduction in water weekly and between patients
Air Path	N/A	Note: Use an inlet filter and bacteria filter	N/A	Note: Use an inlet filter and bacteria filter between patients Keredusy® disinfection (ozone) treatments
Reusable Tubing	mild liquid dishwashing detergent and warm water, weekly	70% Isopropyl Alcohol weekly	mild liquid dishwashing detergent and warm water, weekly and dispose of between patients	70% Isopropyl Alcohol weekly and dispose of between patients
Reusable Gray Foam Filter	rinse monthly and replace every six months. Note: If soil is visible during inspection, rinse more frequently.	N/A	rinse weekly and replace monthly Note: If soil is visible during inspection, rinse more frequently. Note: An in-line bacteria filter must be used in clinical environment.	N/A
Carrying Case	dispose of between patients	N/A	dispose of between patients	N/A
O2 Enrichment Attachment	mild liquid dishwashing detergent and warm water, weekly	70% Isopropyl Alcohol weekly	mild liquid dishwashing detergent and warm water, weekly and dispose of between patients	70% Isopropyl Alcohol weekly and dispose of between patients
Bacteria Filter	IMPORTANT: Use an in-line bacteria filter in the clinical environment. The bacteria filter should be disposed of weekly and between patients.			
Whisper Swivel II	Note: For more information on caring for accessories, refer to the instructions for use that came with the accessory. Review all applicable instructions for additional warnings and cautions.			
In-Use Bag (wheelchair bag)				
Detachable Battery Pack				
Detachable Battery Module				

7.2 Clearing the Device of Patient Data

To eliminate patient confidentiality concerns and to remove previous patient therapy settings, the Clear Patient Data function removes all patient-stored data. If using the device on multiple users, be sure to follow these instructions between patients.

Clear Patient Data

This option appears on the Setup screen when the airflow is off and the device is in Standby. It allows you to clear all patient data and visual alarms stored in the device memory and the device SD Card, if inserted. It also clears the Modem SD Card data.

Note: *The alarm log must be cleared separately.*

Clear Alarm Log

This option appears on the Alarm Log screen when the airflow is off and the device is in Standby. It allows you to clear all displayed alarms and the device SD Card, if inserted. It also clears the Modem SD Card data. Press the button associated with the Clear function, and confirm the action by selecting “Yes.”

Note: *Clearing the alarm logs will not clear the device internal event log.*

Clear Event Log

This option appears on the Event Log screen when the airflow is off and the device is in Standby. It allows you to clear all displayed events. Press the button associated with the Clear function, and confirm the action by selecting “Yes.”

Note: *Clearing the event logs will not clear the device internal alarm log.*

7.3 Cleaning the Ventilator: Exterior

WARNING: To avoid electrical shock, always unplug the power cord from the wall outlet and remove battery cables before cleaning the device.

WARNING: DO NOT immerse the device in any fluids.

WARNING: If using the therapy device on multiple users, discard and replace the bacteria filter each time the device is used on a different patient.

The therapy device's exterior surface should be cleaned weekly or more often if necessary and between patients.

Note: Before cleaning the therapy device, remove the reusable gray foam filter and disposable white ultra-fine filter (if using). For more information, refer to "Caring for the Filters".

1. Turn the therapy device off.
2. Disconnect from the power source.
3. Detach all accessories and connectors.
4. Use a lint-free cloth dampened with water and a mild liquid dish washing detergent solution, and a soft-bristled brush as necessary to clean the exterior of the enclosure. Use 1 teaspoon (5 ml) of liquid dish washing detergent per gallon of water.
5. Pay close attention to all corners and crevices of the therapy device exterior surfaces. Be sure all visible soil is removed.
6. Use a lint-free cloth dampened (not dripping) with clear water to remove all detergent residue.
7. Use a lint-free cloth to wipe the until dry.
8. Inspect the therapy device for cleanliness.
9. Repeat the cleaning steps until the exterior surfaces are visibly clean.
10. Inspect the therapy device for damage after cleaning. If any parts are damaged, contact Philips Respironics Customer Service. Replace any damaged parts.

CAUTION: Allow the therapy device to dry completely before reconnecting to the power source.

7.4 Disinfecting the Ventilator: Exterior

CAUTION: Only the cleaning and disinfection procedures listed in this manual are recommended by Philips Respironics. Use of other cleaning and disinfection procedures, not specified by Philips Respironics, cannot be guaranteed to maintain the performance or durability of the product.

Follow all instructions from the manufacturer of the disinfectant product. Any deviation from these instructions, the manufacturer's instructions, or agents not listed in these instructions may impact the performance of the product.

Disinfect the therapy device exterior surface weekly or more often if necessary and between patients.

Note: Before disinfecting the therapy device exterior, follow the instructions in the section, "Cleaning the Ventilator: Exterior".

Note: Before disinfecting the therapy device, remove the reusable gray foam filter and disposable white ultra-fine filter (if using). For more information, refer to "Caring for the Filters".

Note: Remove the detachable battery module from the therapy device before disinfecting. Inspect the therapy device for damage. If any part is damaged, contact Philips Respironics Customer Service.

1. Use one of the following methods to disinfect all exterior surfaces of the therapy device as indicated:

Isopropyl Alcohol – 70% isopropyl alcohol.

- Use a lint-free cloth dampened with alcohol to initially wipe the exterior of the enclosure to clear visible soil from the surfaces.
- Use a lint-free cloth to thoroughly wet the exterior surfaces with the alcohol.
- Keep wet for 5 minutes.
- Allow to air dry completely.

Chlorine Bleach – containing 8.3% sodium hypochlorite. Combine 10 parts water to 1 part bleach (if available in the home).

- Use a lint-free cloth to initially wipe the bleach solution onto the exterior of the enclosure to clear visible soil from the surfaces.
- Use a lint-free cloth to thoroughly wet the exterior surfaces with the bleach solution.
- Keep wet for 5 minutes.
- Allow to air dry completely.

Note: With the detachable battery module separated from the therapy device, pay close attention to common touch points and all corners and crevices of the therapy device, including the mounting surfaces between the battery module and the therapy device.

2. Inspect the therapy device for damage after disinfection. If any part is damaged, contact Philips Respironics Customer Service. Replace any damaged parts.
3. Replace the detachable battery and reconnect the detachable battery module to the therapy device. Reconnect to the power source.

CAUTION: Allow the therapy device to dry completely before reconnecting to the power source.

7.5 Air Path Disinfection

WARNING: If using the therapy device on multiple users, discard and replace the bacteria filter each time the device is used on a different patient.

Use a bacteria filter to prevent cross contamination between patients.

Remove both the reusable gray foam filter and the disposable white ultra-fine filter before disinfection.

If a home based device is returned and assigned to a new patient, clean and disinfect the device according to the procedures in this chapter. The gas pathway components should be replaced or disinfected by using Keredusy® KR2000 ozone water vapor method process between each new patient use. Contact Philips Respironics Customer Service at +49 8152 93060 for replacement or information about the Keredusy ozone process.

Be certain that any bacteria filter used with this device complies with ISO 23328-1 and ISO 23328-2. To prevent patient or ventilator contamination, you must use a Philips Respironics-approved main flow bacteria filter on the patient gas outlet port. Filters not approved by Philips Respironics may degrade system performance.

For a list of accessories refer to the BiPAP A40 Pro and BiPAP A40 EFL Accessory List (Part Number 1142478) that is included with your ventilator system, or contact Philips Respironics Customer Service.

After disinfection is complete, replace the components that you discarded with new components.

Note: The bacteria filter should be disposed of weekly and between patients.

Note: This product is suitable for use with other patients if a bacteria filter was in use at all times and exchanged between patients or once the above-stated air path disinfection (replacement of gas pathway components or disinfection by using Keredusy® ozone between each new patient use) has been performed.

7.6 Cleaning the Reusable Tubing

Clean the reusable tubing before first use and weekly and dispose of between patients.

1. Disconnect the flexible tubing from the device.
2. Gently wash the tubing in a solution of warm water and a mild detergent.
3. Completely immerse the tubing in a solution of warm water and a mild detergent. Use 1 teaspoon (5 ml) of liquid dish washing detergent per gallon of warm water for 3 minutes.
4. During immersion, gently move the tubing back and forth to loosen and adequately remove adhering substances from the tubing and connectors.

Note: Be sure to clean the entire inner surface of the tube by ensuring it is fully immersed in the detergent solution during gentle agitation by hand.

Note: Be sure to thoroughly rinse all soap residue from the connectors and tubing, and air dry completely before the next use.

5. Rinse thoroughly to remove all soap residue from the tube and connectors.
6. Allow to air dry completely out of direct sunlight.
7. Visually inspect the tubing for cleanliness, including connectors. Repeat the cleaning steps if not visually clean.
8. Inspect the tubing for damage or wear (cracking, crazing, tears, punctures, etc.). Discard and replace if necessary.

Note: Refer to the humidifier manual for the instructions on how to clean the heated tube.

Disinfect the reusable tubing weekly and dispose of between patients.

1. Use 70% isopropyl alcohol to disinfect the reusable tubing. Completely immerse the reusable tubing in alcohol.
2. Keep wet for 5 minutes.

Note: Be sure to clean the entire inner surface of the reusable tubing by ensuring it is fully immersed in the alcohol.

3. Allow to air dry completely out of direct sunlight.
4. Visually inspect the tubing for cleanliness, including connectors. Repeat the cleaning steps if not visually clean.
5. Inspect the tubing for damage or wear (cracking, crazing, tears, punctures, etc.). Discard and replace if necessary.

7.7 Caring for the Filters

In the home, rinse the reusable gray foam filter monthly and replace every six months. In the clinical environment, rinse weekly and replace monthly.

Note: *If soil is visible during inspection, rinse more frequently.*

Note: *An in-line bacteria filter must be used in clinical environment.*

The disposable white ultra-fine filter should be replaced after 30 nights of use or sooner if it appears dirty or damaged. DO NOT rinse the ultra-fine filter.

CAUTION: *Clogged filters may cause high operating temperatures that may affect therapy device performance. Regularly examine the filters as needed for integrity and to check for accumulated debris.*

Follow these steps to rinse the reusable gray foam filter:

1. If the device is operating, stop the airflow. Disconnect the device from the power source.
2. Remove the filter from the therapy device enclosure by gently squeezing the filter in the center and pulling it away from the device.
3. Rinse the reusable gray foam filter thoroughly with water to remove any debris.
4. Shake the filter to remove as much water as possible.
5. Examine the filter for cleanliness and integrity.
6. Allow the filter to air dry completely before reinstalling it. If the filter is damaged, replace it.
7. Replace the disposable white ultra-fine filter if it is damaged or has accumulated any debris.
8. Reinstall the filters, inserting the disposable white ultra-fine filter first (if applicable).

Note: *The disposable white ultra-fine filter places between the device and reusable gray foam filter. The reusable gray foam filter must face outward.*

Note: *Only Philips Respironics-supplied filters should be used as replacement filters.*

CAUTION: *Never install a wet filter into the device. Allow sufficient drying time for the filter.*

7.8 Cleaning and Disinfecting the O₂ Enrichment Attachment

Clean the O₂ Enrichment Attachment before first use and weekly.

1. Disconnect all tubing from the device and the O₂ Enrichment Attachment connector.
2. Gently wash the attachment connector in a solution of warm water and a mild detergent.
3. Completely immerse the attachment connector in a solution of warm water and a mild detergent. Use 1 teaspoon (5 ml) of liquid dish washing detergent per gallon of warm water for 3 minutes.
4. During immersion, gently move the attachment connector back and forth to loosen and adequately remove adhering substances.

Note: Be sure to clean the entire inner surface of the attachment connector by ensuring it is fully immersed in the detergent solution during gentle agitation by hand.

5. Rinse thoroughly to remove all soap residue from the attachment connector.
6. Allow to air dry completely out of direct sunlight.
7. Visually inspect the attachment connector for cleanliness. Repeat the cleaning steps if not visually clean.
8. Inspect the attachment connector for damage or wear (cracking, crazing, tears, punctures, etc.). Discard and replace if necessary.

Disinfect the O₂ Enrichment Attachment weekly and dispose of between patients.

1. Use 70% isopropyl alcohol to disinfect the interior and exterior surface. Completely immerse the attachment connector in alcohol.
2. Keep wet for 5 minutes.

Note: Be sure to clean the entire inner surface of the attachment connector by ensuring it is fully immersed in the alcohol.

3. Allow to air dry completely out of direct sunlight.
4. Visually inspect the attachment connector for cleanliness. Repeat the cleaning steps if not visually clean.
5. Inspect the attachment connector for damage or wear (cracking, crazing, tears, punctures, etc.). Discard and replace if necessary.

7.9 Cleaning and Disinfection of the Detachable Battery (When Available)

Clean the detachable battery weekly or more often if necessary and between patients. Disinfect the detachable battery exterior surfaces weekly or more often if necessary and between patients. Refer to the detachable battery accessory instructions for use for complete steps for cleaning and disinfection (as applicable)..

7.10 Cleaning and Disinfection of the Detachable Battery Module (When Available)

Clean the detachable battery module weekly or more often if necessary and between patients. Disinfect the detachable battery module interior and exterior surfaces weekly or more often if necessary and between patients. Refer to the detachable battery module accessory instructions for use for complete steps for cleaning and disinfection (as applicable).

7.11 Cleaning and Disinfection of the Whisper Swivel II

The Whisper Swivel II device may be cleaned and disinfected daily or as needed between patients. For complete cleaning and disinfection information, refer to the instructions that came with the device. Be sure to follow all instructions from the manufacturer of the disinfection products. Review all applicable instructions for additional warnings and cautions.

Note: For more information on caring for other accessories, such as the humidifier, please refer to the instructions for use that came with the accessory.

7.12 Wiping Down the Roll Stand

Wipe down the roll stand as needed or between patients.

1. Disconnect and remove attached cables, accessories, and devices, before wiping down the roll stand.
2. Use a lint-free cloth dampened (not dripping) with a mild liquid dish washing detergent solution to wipe the roll stand surfaces. Use 1 teaspoon (5 ml) of liquid dish washing detergent per gallon of water.
3. Wipe any visible soil from the roll stand.
4. Use a lint-free cloth dampened (not dripping) with water to remove all detergent residue.
5. Allow the roll stand to air dry completely.

7.13 Service

The ventilator does not require preventative maintenance.

If service is required, contact Philips Respironics or an authorized service representative to have the device serviced. Contact Philips Respironics Customer Service department at 1-724-387-4000 (USA) or +49 8152 93060 (Germany).

You may also use the following addresses:

Respironics Inc.	Respironics Deutschland GmbH & Co. KG
1001 Murry Ridge Lane	Gewerbestrasse 17
Murrysville, PA 15668 USA	82211 Herrsching, Germany

8. Accessories

Several accessories are available for use with this device.

To prevent adverse performance, use only accessories intended for use with BiPAP A40 Pro or BiPAP A40 EFL, including circuits, patient monitors and power accessories.

When using optional accessories, always follow the instructions included with the accessories. Be certain accessories and parts are compatible before you connect a patient to the device.

For a list of accessories refer to the BiPAP A40 Pro and BiPAP A40 EFL Accessory List (Part Number 1142478) that is included with your ventilator system, or contact Philips Respironics Customer Service.

8.1 Adding a Integrated System One Humidifier (with or without Heated Tubing)

You can use the integrated System One heated humidifier and the heated tube with your ventilator. They are available from your home care equipment provider. A humidifier and heated tube may reduce nasal dryness and irritation by adding moisture to the airflow.

Note: Refer to the System One humidifier's instructions for complete setup information.

When the device is in Standby, if the integrated humidifier or the heated tube is connected, and the humidifier parameter setting is greater than 0, the Left key is labeled Preheat. Selecting this key initiates the humidifier preheat function and changes the humidifier icon to the "heating active" icon. Selecting this key again while the preheat function is active will end the pre-heat function. After the heater plate reaches the desired temperature, the Preheat feature automatically shuts off.

8.2 Adding an External Humidifier

You can use an external heated humidifier and heated tube with your ventilator. The external humidifier may be used for non-invasive and invasive humidification for patients with bypassed airways. Contact your home care equipment provider for additional information on external humidifiers and their accessories.

Note: Refer to the external humidifier's instructions for complete setup information.

Note: The external humidifier is not intended for use with ExpiraFlow is enabled.

8.3 Supplemental Oxygen

Oxygen (up to 15 LPM) may be added into the oxygen inlet port on the back of the ventilator. The oxygen supply must comply with the local regulations for medical oxygen. Refer to the oxygen warnings in Chapter 1 when using oxygen with the device.

8.4 Oximeter

You can connect the recommended oximetry device to the ventilator to monitor SpO₂ and heart rate levels. When an oximeter is connected, the Patient Accessory panel appears on the Standby and Monitor screens. A heart icon will indicate that the oximeter is connected and show the data status. When the device has Detailed View turned on, the panel also displays the current SpO₂ and Heart Rate readings. If bad data is being read from the oximeter, dashes appear next to the SpO₂ and Heart Rate indicators.

Note: Use only the oximetry device available from Philips Respironics.

8.5 SD Card

The system comes with an SD card inserted in the SD card slot on the back of the device to record information for the home care equipment provider. Your provider may ask you to periodically remove the SD card and send it to them for evaluation.

To remove the SD card:

1. Select the “Safely Remove SD Card” option from the main menu.
2. After the “Remove SD Card” confirmation message appears, remove the card.

To write an Event Log to the SD card:

1. Place the device in Stand-by mode.
2. Access the Setup screen in Full Menu Access mode.
3. Select the “Write Event Log to SD Card” option from the main menu.
 - While writing is in progress, a confirmation box with the message “Writing in Progress” appears.
 - When writing is complete, a confirmation box with the message “Writing Successful” appears.
 - If the write could not happen, a confirmation box with the message “Writing Failed” appears.

Note: *The SD card does not need to be installed for the device to work properly.*

Note: *Use only SD cards available from Philips Respironics that are designated for this device.*

For details on updating a prescription using the SD card, see Chapter 5.

8.6 Care Orchestrator Essence

Philips Respironics Care Orchestrator Essence software is designed for use with this Philips Respironics ventilator. Care Orchestrator Essence is a solution that allows healthcare representatives involved in a patient's therapy lifecycle the ability to manage patients and referrals; control access to patient information; and view and interact with therapy and prescription data from Philips Respironics devices. Patient information may be managed between the device and Care Orchestrator Essence using SD card.

8.7 Respiratory Lithium-Ion Battery

A Respiratory Lithium-Ion Battery can be connected to the ventilator through the Philips Respironics BiPAP cable. The battery is intended to provide power in locations where AC power is not easily accessible. Refer to the instructions included with your Respiratory Lithium-Ion Battery for more information. The availability of the Respiratory Lithium-Ion Battery is not meant to suggest that this product can be used as a transport ventilator.

8.8 Detachable Battery and Detachable Battery Module

A rechargeable Lithium-Ion detachable battery is available for use with BiPAP A40 Pro and BiPAP A40 EFL ventilators. Connect the battery to the device and recharge it using the Detachable Battery Module. See the instructions included with your detachable battery and Detachable Battery Module for more information.

8.9 Roll Stand

A roll stand available for use with BiPAP A40 Pro and BiPAP A40 EFL ventilators. See the instructions included with your roll stand for more information.

8.10 In-Use Bag

An In-Use bag is available for use with the BiPAP A40 Pro ventilator. The bag is not for use with the humidifier. The bag is designed to attach the ventilator to a wheelchair. See the instructions included with the in-use bag for more information.

Note: *The In-Use Bag is not intended for use while Low Flow Oxygen is in use.*

8.11 Carry Case

A carry case is available for transporting your ventilator. When traveling, the carry case is for carry-on luggage only. The carry case will not protect the system if it is put through checked baggage.

8.12 Accessory Modules and Modems

Optional accessories designed for use with this Philips Respironics ventilator are available, such as the link module and Bluetooth accessory module, and cellular and broadband/SpO₂ modems.

When installed, therapy compliance data can be collected from the device and the data can be automatically transmitted. Home care equipment providers (HCPs) and medical professionals can then use this information as one of several elements to evaluate patient compliance, and if necessary, change the therapy device's settings.

Refer to the instructions supplied with the accessory for more information.

9. Troubleshooting

This chapter lists some of the problems that you may experience with your device and possible solutions to those problems.

Problem	What to do
Why isn't my device turning on? The backlight on the buttons does not light.	<p>If you are using AC power:</p> <ul style="list-style-type: none"> • Check the outlet and verify that the device is properly plugged in. • Make sure there is power available at the outlet and that the AC power cord is connected correctly to the power supply and the power supply cord is securely connected to the device's power inlet. <p>If you are using an external power source:</p> <ul style="list-style-type: none"> • Make sure the DC power cord and battery adapter cable connections are secure. • Check the battery. It may need recharged or replaced. • If the problem persists, and if you are using a lead acid battery, check the DC cord's fuse following the instructions supplied with the DC cord. The fuse may need to be replaced. • If the problem still occurs, contact your home care equipment provider.
Why isn't the airflow turning on?	<p>Make sure the device is powered correctly.</p> <ul style="list-style-type: none"> • Verify that you are not in Standby mode. The airflow remains off while in Standby. • Press the Therapy button to be sure therapy is on. • If problem persists, contact product support for assistance.
Why is the airflow much warmer than usual?	<p>The air filters may be dirty. Clean or replace the air filters.</p> <ul style="list-style-type: none"> • The temperature of the air may vary somewhat based on the room temperature. Make sure the device is properly ventilated. Keep it away from bedding or curtains that could block the flow of air around the device. • Make sure the device is away from direct sunlight and heating equipment. • If using the humidifier with the device, check the humidifier settings. Refer to the humidifier instructions to make sure the humidifier is working properly.

Problem	What to do
Why does the mask feel uncomfortable?	<p>This could be due to improper headgear adjustment or improper mask fitting.</p> <ul style="list-style-type: none"> • Make sure the patient is properly fitted with the correct size mask. • If the problem continues, contact your home care equipment provider to be fitted with a different mask.
Excessive Leak The ventilator can no longer assure that the prescribed therapy is being delivered.	<ul style="list-style-type: none"> • Reconnect the patient circuit. • Fix the leak by adjusting or replacing the mask. • If conducting an ExpiraFlow screening test, re-start the ExpiraFlow Screening process. • If the alert continues to occur, contact your home care equipment provider.
Why did my prescription change fail when I updated my prescription using the SD card?	<p>There are three possible error messages that will appear if the prescription change fails when using an SD card:</p> <ul style="list-style-type: none"> • Prescription Change Failed: Remove the card and have the prescription replaced with a valid prescription. • Prescription Failed – Serial Number: Remove the card and have the prescription replaced with the prescription with the correct serial number. • Prescription Failed – Version: Remove the card and have the prescription replaced with a prescription in the correct version.
Why isn't my detachable battery charging when it is inserted into the Detachable Battery Module and the device is running on AC power?	<p>The battery may not charge if the device is too hot or too cold or is operating at an ambient temperature outside of the specified valid range. Or, the device may not have enough power to charge the battery if the humidifier is in use.</p> <ul style="list-style-type: none"> • Make sure the device is not too close to a heat source. • Be sure the air vents are not blocked. • Bring the device to ambient room temperature. • Allow the battery to charge while the device is in Standby, or while the airflow is on and humidifier is off. • Use the optional Philips Respironics Detachable Battery Charger to charge your battery. • If the problem continues, contact an authorized service representative or Philips Respironics to have the device serviced. Please have the model number and serial number ready when you call. If you are a patient, please contact your home care equipment provider.

The following are some of the problems you may experience during the ExpiraFlow Screening process and possible solutions to those problems.

Problem	What to do
<p>The ExpiraFlow Screening process will not start. The error message, “Disconnect Humidifier” displays.</p>	<ul style="list-style-type: none"> • Select OK. The ExpiraFlow Screening process will end. • Disconnect the humidifier. • Re-start the ExpiraFlow Screening process.
<p>Excessive Leak (Amber ●) Large leak value indicating it is no longer possible to calculate ΔXrs to determine respiratory events with statistical accuracy.</p>	<ul style="list-style-type: none"> • Reconnect the patient circuit. • Fix the leak by adjusting or replacing the mask. • Re-start the ExpiraFlow Screening process.
<p>Low Leak (Amber ●) Leak is not sufficient to allow calculation of EFL.</p>	<ul style="list-style-type: none"> • Check for blockages in exhalation devices. • Ensure the exhalation device is clean and functioning properly. • Fix the leak by adjusting or replacing the mask. • Re-start the ExpiraFlow Screening process.
<p>Invalid Breath The percentage of Valid Breaths falls below the threshold to accurately calculate if the patient has EFL.</p>	<ul style="list-style-type: none"> • Ensure the patient is calm and breathing normally. • Check the patient circuit and reconnect if needed. • Fix the leak by adjusting or replacing the mask. • Re-start the ExpiraFlow Screening process. <p>Note: <i>The percentage of valid breaths is the number of valid breaths divided by the total breaths during the screening process. At least 80% of the breaths during screening must be valid for the screening to be considered valid. If the percentage of valid breaths during screening are less than 80%, the screening test will fail.</i></p> <p>Note: <i>Repeat the screening test if valid breaths are less than 80%.</i></p>
<p>If an alarm occurs during the ExpiraFlow Screening process.</p>	<ul style="list-style-type: none"> • Ensure the patient is calm. • Ensure that adequate therapy is available. • Acknowledge the alarm by pressing the Clear key at lower left. • Re-start the ExpiraFlow Screening process.

10. Technical Specifications

Environmental

	Operating	Storage
Temperature	5° C to 40° C (41° F to 104° F)	-20° C to 60° C (-4° F to 140° F)
Relative Humidity	15 to 95% (non-condensing)	15 to 95% (non-condensing)
Atmospheric Pressure	101 kPa to 77 kPa (0-2286 m / 0-7500 ft)	n/a

Physical

Dimensions: 22.23 cm W x 18.42 cm L x 10.80 cm H (8.75" W x 7.25" L x 4.25" H)

Weight: Approximately 2 kg (4.4 lbs)

Electrical

AC Voltage Source	100 to 240 VAC, 50/60 Hz, 2.0 – 1.0 A
DC Power Source	12 VDC, 5.0 A (External Battery) 24 VDC, 4.2 A (Power Supply)
Type of Protection Against Electric Shock	Class II Equipment (To be used with external Class II supply only)
Degree of Protection Against Electric Shock	Type BF Applied Part
Degree of Protection Against Ingress of Water	Device: Drip Proof, IP22 First characteristic numeral - 2 - Protection against ingress of solid foreign objects \geq 12.5 mm diameter. Explanation: Protected against access to hazardous parts with a finger and protected against solid foreign objects of 12.5 mm diameter and greater. Second characteristic numeral - 2 - Protection against ingress of water with harmful effects dripping (15° tilted). Explanation: Protected against vertically falling water drops when enclosure tilted up to 15°.
Mode of Operation	Continuous

Sound

Declared Dual-Number Noise Emissions Values In accordance with ISO 4871

Alarm Sound Pressure Level

60 dB(A) - 85 dB(A)

Note: Range values determined per IEC 60601-1-8.

Note: The sound level may be reduced when the device is used in the In-Use bag.

Sound Pressure Level (Noise)	Device without humidifier: 28.83 dB(A) as measured at CPAP = 10 cm H ₂ O
	Device with empty humidifier: 30.26 dB(A) as measured at CPAP = 10 cm H ₂ O
	Bi-level device measured at 500 ml without humidifier: 30.94 dB(A)
	Bi-level device measured at 500 ml with empty humidifier: 31.46 dB(A)

Sound Power Level

Ventilator, circuit and exhalation device; worst case configuration:
39.46 dB(A)

Note: Values determined according to noise test code using the basic standards ISO 3744 and ISO 4871.

Breathing Resistance During Power Fail or Fault Conditions

The resistance measurements include the complete system, with outlet bacteria filter, and patient circuit.

Patient Flow (LPM)	Expiratory Resistance (cm H ₂ O)	Inspiratory Resistance (cm H ₂ O)
30	<1.7	<1.9
60	<4.9	<5.5

Oxygen (Delivered by way of the Oxygen Inlet Adapter)

Low Flow Range: 0 to 15 l/min
Maximum Pressure: 10 psi

Patient Tubing Compliance

Tested per the method described in ISO 5367:

Tube Type	Compliance Limit (ml/cm H ₂ O)	At Pressure (cm H ₂ O)
15 (mm) tubing type	.51	61.18
22 (mm) tubing type	.74	61.18

Pulse Oximeter

Displayed Oxygen Saturation Range (SpO ₂):	0 to 100% with a resolution of 1%
Displayed Heart Rate Range:	18 to 321 beats per minute with a resolution of 1
SpO ₂ and Heart Rate Accuracy:	See the sensor instructions.
Data update period:	Every second
Data averaging:	4 beat average, updated every second

Control Accuracy Table

Parameter	Range	Accuracy
IPAP	4 – 40 cm H ₂ O	± 2.5 cm H ₂ O *
EPAP	4 – 25 cm H ₂ O	± 2.5 cm H ₂ O *
CPAP	4 – 20 cm H ₂ O	± 2.5 cm H ₂ O *
Breath rate	0 to 40 BPM	greater of ± 1 BPM or ±10% of setting
Inspiration time	0.5 to 3 seconds	± (10% of setting + 0.1 second)

Note: Tolerances listed in the Control Accuracy Table have a measurement uncertainty of 3.72%.

* Pressure measured at the patient connection port with or without the integrated heated humidifier (no patient flow).

Specifications listed are based on using a standard patient circuit (Philips Respironics 15 mm or 22 mm tubing; Whisper Swivel II).

Displayed Parameter Accuracy

Parameter	Range	Accuracy	Resolution
Estimated Patient Pressure	0 to 40 cm H ₂ O	±2.5 cm H ₂ O	0.1 cm H ₂ O
Exhaled Tidal Volume	0 to 2000 ml	Greater of ±20 ml or ±20% of reading	1 ml
Estimated Leak Rate	0 to 175 LPM	N/A	0.1 LPM
Exhaled Minute Ventilation	0 to 25 LPM	Calculation based on Exhaled Tidal Volume and Respiratory Rate	0.1 LPM
Respiratory Rate	0 to 60 BPM	Greater of ±1 BPM or ±10% of reading	1 BPM
I:E Ratio	9.9:1 to 1:9.9	Calculation based on Inspiratory time and Expiratory time	0.1

Displayed Parameter Accuracy (BiPAP A40 EFL only)

Delta Xrs (ΔXrs)	0 to 25 cm H ₂ O/l/s	Greater of ±10% or 0.5 cm H ₂ O/l/s	0.5 cm H ₂ O
EFL Percentage	0 to 100%	Calculation based on the percentage of flow limited breaths and valid breaths, ±10%	1%
Respiratory System Resistance (R _{total})	0 to 999 cm H ₂ O/l/s	Calculation based on resistance, ±10%	0.1 cm H ₂ O/l/s

Note: Tolerances listed in the Displayed Parameter Accuracy Table have a measurement uncertainty of 3.72%.

Note: Displayed parameter accuracies are based on bench top conditions at an altitude of nominally 380 meters. Refer to the Environmental technical specifications for operating devices in this chapter. All flow based parameters are expressed in volumetric flow.

Note: Pressure measured at the patient connection port with or without the integrated heated humidifier (no patient flow).

Disposal

Separate collection for electrical and electronic equipment per EC Directive 2012/19/EU. Dispose of this device in accordance with local regulations.

Expected Service Life

Ventilator (including power cord and power supply):	5 years
Detachable Battery Pack (if included):	5 years
Flexible Tubing:	6 months
Reusable Grey Foam Filter:	6 months
Ultra-Fine Filter:	1 month

SD Card and SD Card Reader

Use only SD cards and SD card readers available from Philips Respironics.

For a list of accessories refer to the BiPAP A40 Pro and BiPAP A40 EFL Accessory List (Part Number 1142478) that is included with your ventilator system, or contact Philips Respironics Customer Service.

Pneumatic Diagram

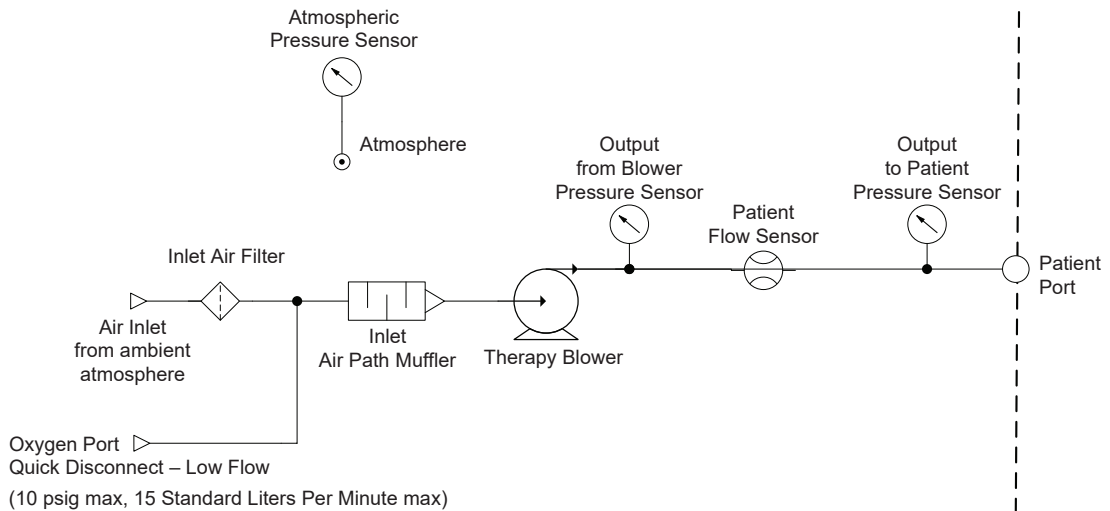

Standards Compliance

This device is designed to conform to the following standards:

- IEC 60601-1: Medical Electrical Equipment – Part 1: General Requirements for Basic Safety and Essential Performance
- IEC 60601-1-2: Medical Electrical Equipment – Part 1-2: General Requirements for Basic Safety and Essential Performance – Collateral standard: Electromagnetic compatibility – Requirements and tests
- IEC 60601-1-6: Medical Electrical Equipment – Part 1-6: General Requirements for Safety and Essential Performance – Collateral standard: Usability
- IEC 60601-1-8: Medical Electrical Equipment – Part 1-8: General Requirements for Basic Safety and Essential Performance – Collateral standard: General Requirements, tests and guidance for alarm systems in medical electrical equipment and medical electrical systems
- IEC 60601-1-11: Medical Electrical Equipment – Part 1-11: General Requirements for Basic Safety and Essential Performance – Collateral standard: Requirements for medical electrical equipment and medical electrical systems used in the home healthcare environment
- ISO 10651-6: Lung Ventilators for Medical Use – Particular Requirements for Basic Safety and Essential Performance, Part 6. Home care ventilatory support devices
- ISO 80601-2-61: Medical Electrical Equipment – Part 2-61: Particular Requirements for Basic Safety and Essential Performance of pulse oximeter equipment
- ISO 8185 General Requirements for Humidification Systems
- RTCA DO-160 Section 21, Category M; Emission of Radio Frequency Energy

11. EMC Information

EMC Information

Your unit has been designed to meet EMC standards throughout its Service Life without additional maintenance. There is always an opportunity to relocate your device within an environment that contains other devices with their own unknown EMC behavior. If you believe your unit is affected by locating it closer to another device, simply separate the devices to remove the condition.

Pressure and Flow Accuracy

This therapy device is designed to perform within the pressure and flow rate accuracies specified in the user manual. If you suspect that the pressure and/or flow rate accuracy is affected by EMC interference remove power and relocate the device to another area. If performance continues to be affected discontinue use and contact your home care equipment provider.

SpO₂ and Heart Rate Accuracy

This therapy device is designed to capture the SpO₂ and Heart Rate oximetry data within the accuracy specification described in the sensor manufacture's instructions for use. If you suspect that your unit is affected by EMC interference remove power and relocate the device to another area. If performance continues to be affected discontinue use and contact your home care equipment provider.

WARNINGS:

- *Use of this equipment adjacent to or stacked with other equipment should be avoided because it could result in improper operation. If such use is necessary, this equipment and the other equipment should be observed to verify that they are operating normally.*
- *To ensure that you receive safe, effective therapy, use only Philips Respironics accessories. The use of accessories, transducers, and cables other than those specified by Philips Respironics may result in increased emissions or decreased immunity of the device.*
- *Portable and Mobile RF Communications Equipment can affect Medical Electrical Equipment. See the EMC section of this manual for distances to observe between RF Generators and the ventilator to avoid interference.*
- *Do not use this device near active high frequency surgical equipment and the Radio Frequency shielded room of a Medical Electrical system for magnetic resonance imaging, where the intensity of electromagnetic disturbances is high.*

Guidance and Manufacturer's Declaration - Electromagnetic Emissions

This device is intended for use in the electromagnetic environment specified below. The user of this device should make sure it is used in such an environment.

Emissions Test	Compliance	Electromagnetic Environment - Guidance
RF radiated emissions CISPR 11	Group 1 Class B	The device uses RF energy only for its internal function. Therefore, its RF emissions are very low and are not likely to cause any interference in nearby electronic equipment.
RF emissions CISPR 11	Group 1 Class B	The device is suitable for use in all establishments, including domestic establishments and those directly connected to the public low-voltage power supply network.
Harmonic emissions IEC 61000-3-2	Class A	
Voltage fluctuations/ Flicker emissions IEC 61000-3-3	Complies	
Emission of Radio Frequency Energy RTCA/DO-160 Section 21	Category M	This device is suitable for use onboard commercial airplanes inside passenger cabin.

Guidance and Manufacturer's Declaration - Electromagnetic Immunity

This device is intended for use in the electromagnetic environment specified below. The user of this device should make sure it is used in such an environment.

Immunity Test	IEC 60601 Test Level	Compliance Level	Electromagnetic Environment - Guidance
Electrostatic Discharge (ESD) IEC 61000-4-2	±8 kV contact discharges ±2 kV, ±4 kV, ±8 kV, and ±15 kV air discharges	±8 kV contact discharges ±2 kV, ±4 kV, ±8 kV, and ±15 kV air discharges	Floors should be wood, concrete or ceramic tile. If floors are covered with synthetic material, the relative humidity should be at least 35%.
Electrical fast Transient/burst IEC 61000-4-4	±2 kV for power supply lines and ±1 kV for input-output lines; both at 100 kHz repetition rate.	±2 kV at 100 kHz repetition rate for power supply lines N/A - Device does not have user I/O lines that are longer than 3m in length.	Mains power quality should be that of a typical home or hospital environment.
Surge IEC 61000-4-5	±1 kV differential mode ±2 kV common mode	±1 kV differential mode N/A - Device is Class 2 and does not have earth connection.	Mains power quality should be that of a typical home or hospital environment.
Voltage dips, short interruptions and voltage variations on power supply input lines IEC 61000-4-11	<5% U_T (>95% dip in U_T) for 0.5 cycle at 45 degree increments <5% U_T (>95% dip in U_T) for 1 cycle 70% U_T (30% dip in U_T) for 0.5 seconds <5% U_T (>95% dip in U_T) for 5 seconds	<5% U_T (>95% dip in U_T) for 0.5 cycle at 45 degree increments <5% U_T (>95% dip in U_T) for 1 cycle 70% U_T (30% dip in U_T) for 0.5 seconds <5% U_T (>95% dip in U_T) for 5 seconds	Mains power quality should be that of a typical home or hospital environment. If the user of the device requires continued operation during power mains interruptions, it is recommended that the device be powered from an uninterruptible power supply or a battery.
Power frequency (50/60 Hz) magnetic field IEC 61000-4-8	30 A/m	30 A/m	Power frequency magnetic fields should be at levels characteristic of a typical location in a typical hospital or home environment.

Note: U_T is the a.c. mains voltage prior to application of the test level.

Guidance and Manufacturer's Declaration - Electromagnetic Immunity

This device is intended for use in the electromagnetic environment specified below.

The user of this device should make sure it is used in such an environment.

Immunity	IEC 60601 Test Level	Compliance Level	Electromagnetic Environment - Guidance
Conducted RF IEC 61000-4-6	3 Vrms 150 kHz to 80 MHz	3 Vrms 150 kHz to 80 MHz	Portable and mobile RF communications equipment should be used no closer to any part of the device, including cables, than the recommended 30 cm (12 inches) separation distance.
	6 Vrms Amateur Radio & ISM Bands between 150 kHz and 80 MHz	6 Vrms Amateur Radio & ISM Bands between 150 kHz and 80 MHz	
Radiated RF IEC 61000-4-3	10 V/m 80 MHz to 2.7 GHz	10 V/m	Interference may occur in the vicinity of equipment marked with the following symbol: 
	Telecommunication frequencies as specified in clause 8.10 of IEC 60601-1-2: 2014:		
	450, 810, 870, 930, 1720, 1845, 1970, and 2450 MHz at 28 V/m	28 V/m	
	385 MHz at 27 V/m	27 V/m	
	710, 745, 780, 5240, 5500, and 5785 MHz at 9 V/m	9 V/m	

Limited Warranty

Respironics, Inc. warrants that the BiPAP A40 Pro and BiPAP A40 EFL system shall be free from defects of workmanship and materials and will perform in accordance with the product specifications for a period of two (2) years from the date of sale by Respironics, Inc. to the dealer. If the product fails to perform in accordance with the product specifications, Respironics, Inc. will repair or replace – at its option – the defective material or part. Respironics, Inc. will pay customary freight charges from Respironics, Inc. to the dealer location only. This warranty does not cover damage caused by accident, misuse, abuse, alteration, and other defects not related to material or workmanship.

Respironics, Inc. disclaims all liability for economic loss, loss of profits, overhead, or consequential damages which may be claimed to arise from any sale or use of this product. Some states do not allow the exclusion or limitation of incidental or consequential damages, so the above limitation or exclusion may not apply to you.

Accessories and replacement parts, including, but not limited to, circuits, tubing, leak devices, exhaust valves, filters and fuses, are not covered under this warranty.

This warranty is given in lieu of all other express warranties. In addition, any implied warranties – including any warranty of merchantability or fitness for the particular purpose – are limited to two years. Some states do not allow limitations on how long an implied warranty lasts, so the above limitation may not apply to you. This warranty gives you specific legal rights, and you may also have other rights which vary from state to state.

To exercise your rights under this warranty, contact your local authorized Respironics, Inc. dealer or contact Respironics, Inc. at:

1001 Murry Ridge Lane
Murrysville, Pennsylvania 15668-8550
1-724-387-4000

Deutschland
Gewerbestrasse 17
82211 Herrsching Germany
+49 8152 93060

Note: For Australian and New Zealand customers this warranty replaces the warranty contained above.

1. Respiroics, Inc., a Philips Healthcare company (“Philips Respiroics”), warrants that the Products shall be free from defects of workmanship and materials and will perform in accordance with the Product specifications. 2. This warranty is valid for a period of two (2) years from the date of purchase from an authorized Philips Respiroics dealer. 3. If the Product is found to contain a defect of workmanship or materials or fails to perform in accordance with the Product specifications during the applicable warranty period, Philips Respiroics will repair or replace, at its option, the defective material or part. 4. The customer is responsible for returning the product to an authorised Philips Respiroics dealer, and collecting the product from the authorised Philips Respiroics dealer after repair or replacement, at its own cost. Philips Respiroics is responsible only for the freight cost of transporting the product between the authorised Philips Respiroics dealer and Philips Respiroics. Philips Respiroics reserves the right to charge an evaluation and postage fee for any returned Product as to which no problem is found following investigation. 5. This warranty does not cover damage caused by accident, misuse, abuse, alteration, and other defects not related to materials or workmanship. 6. The warranty provided by Philips Respiroics herein is not transferrable by the Buyer in the event of any sale or transfer of Products purchased by the Buyer from an authorized Philips Respiroics dealer. 7. To the extent permitted by law, where the Buyer has the benefit of an implied guarantee under the Australian Consumer Law, but the Product is not of a kind ordinarily acquired for personal, domestic or household use or consumption Philips Respiroics’ liability shall be limited, at the option of Philips Respiroics, to the replacement or repair of the Product or the supply of an equivalent Product. 8. To exercise your rights under this warranty, contact your local authorised Philips Respiroics dealer. A list of all authorised dealers is available at the following link: <http://www.philips.com.au/healthcare>.

Alternatively, you can make a claim under this warranty by contacting Philips Respiroics directly at: Philips Electronics Australia Limited, 65 Epping Road, North Ryde NSW 2113, Australia. Tel: 1300 766 488, Email: prcontact@philips.com. 9. The following statement is provided to a Buyer who is a “consumer” under the Australian Consumer Law: *Our goods come with guarantees that cannot be excluded under the Australian Consumer Law. You are entitled to a replacement or refund for a major failure and for compensation for any other reasonably foreseeable loss or damage. You are also entitled to have the good repaired or replaced if the goods fail to be of acceptable quality and the failure does not amount to a major failure.* 10. The following statement is provided to a Buyer who is a “consumer” under the Consumer Guarantees Act 1993, New Zealand: *Our goods come with guarantees that cannot be excluded under the Consumer Guarantees Act 1993. This guarantee applies in addition to the conditions and guarantees implied by that legislation.*