

PHILIPS

Adapter Ring A

H7-LED

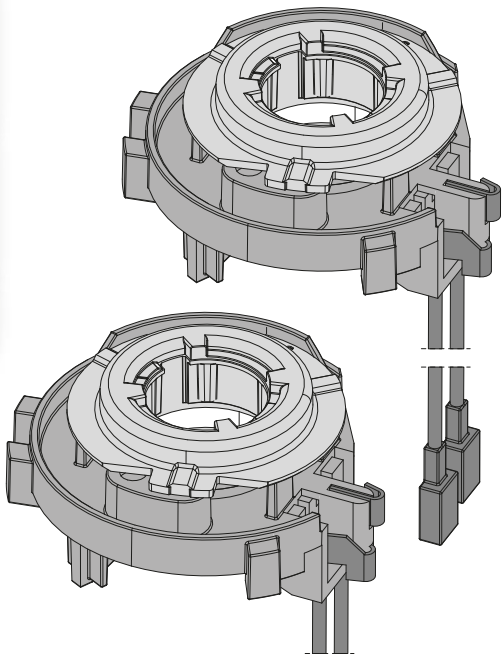

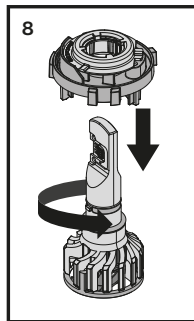
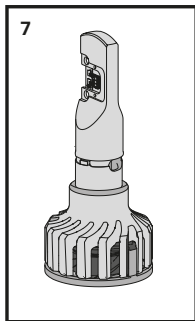
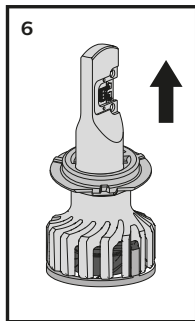
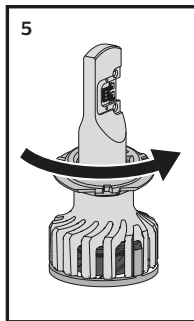
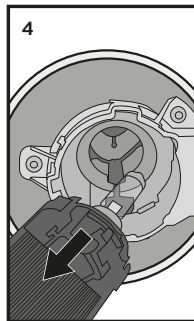
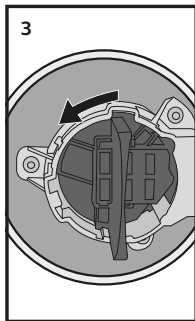
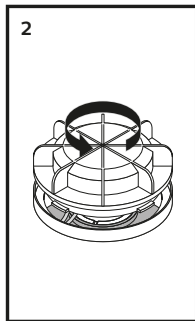
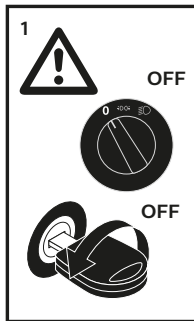

9

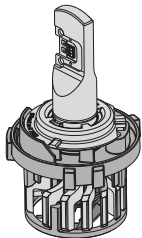

10

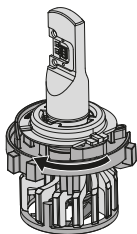

11

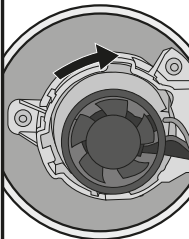

12

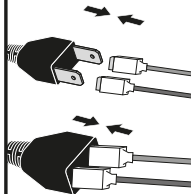

13



14

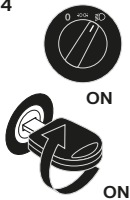

15

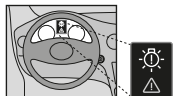
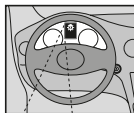

Für Deutschland

Pour la FRANCE



www.philips.de/
LED-Strassenbeleuchtung
www.philips.fr/
LEDHomologation



Lumileds est le garant de ce produit.

2022 © Lumileds Holding B.V. Tous droits réservés. La marque commerciale Philips et l'emblème du bouclier Philips sont la propriété de Koninklijke Philips N.V. et sont utilisés sous licence.

Lumileds ist der Garantiegeber für dieses Produkt.

**Philips und das Philips Wappen sind eingetragene Marken von Koninklijke Philips N.V. und werden unter Lizenz verwendet.
©2022 Lumileds Holding B.V. Alle Rechte vorbehalten.**

Lumileds is the warrantor of this product.

**Philips and the Philips Shield Emblem are registered trademarks of Koninklijke Philips N.V. and are used under license.
© 2022 Lumileds Holding B.V. All rights reserved.**

